



## **APPENDIX D**

I.	REGULATED RESIDENTIAL INFILL GUIDANCE .....	3
II.	GREEN INFRASTRUCTURE CONTROLS .....	9
III.	RESIDENTIAL INFILL STORMWATER CREDIT FOR EXISTING TREES .....	35
IV.	TESTING INFILTRATION: THE SIMPLE APPROACH .....	36
V.	RECOMMENDED PLANTS .....	37
VI.	THE SIMPLE METHOD OF DETERMINING ADEQUATE FLOW AREA .....	45
VII.	DECLARATION OF RESTRICTIONS AND COVENANTS FOR SCMS FOR REGULATED RESIDENTIAL INFILL .....	47
VIII.	LONG TERM MAINTENANCE PLAN INSTRUCTIONS .....	55



**Metropolitan Nashville – Davidson County  
Stormwater Management Manual  
Volume 1 - Regulations**

**2021**

*This page left blank intentionally*



# I. REGULATED RESIDENTIAL INFILL GUIDANCE

## Introduction

This document was produced based upon the City of Atlanta's *Green Infrastructure for Single Family Residences*.

## Background and Purpose

Land development permanently alters the way in which stormwater flows across a site due to grading, compaction, and the installation of impervious cover. In order to mitigate these impacts, Metro Nashville requires, in accordance with Municipal Code 15.64.010 et seq., post development stormwater management measures be utilized when constructing a new home or an addition that meets the criteria outlined in the Stormwater Management Manual Volume 1 Chapter 8, *Regulated Residential Infill Requirements and Procedures*.

The purpose of this document is to provide a guideline for selecting and installing the appropriate stormwater management measures when constructing a home.

This guideline employs simplified design standards more applicable to the homeowner/builder experience, thus avoiding the necessity for complex engineering calculations and analysis.

## Which projects are included and what is required?

Projects that create 800 to 15,000 square feet of additional net impervious area through new development, redevelopment, or rehabilitation of a residential structure in existing neighborhoods are included in the regulations below.

**Tier I** - Projects creating between **800** and **2,500** square feet of net additional impervious area and with the total lot impervious area percentage exceeding 30% must treat, by means of capture of the first inch of rainfall runoff, an impervious area equal to the net increase of added impervious area.

**Tier II** - Projects creating between **2,500** and **8,000** square feet of net additional impervious area, without regard to total lot impervious area percent must treat, by means of capture of the first inch of rainfall runoff, an impervious area equal to the net increase of added impervious area.

**Tier III** – Projects creating between **8,000** and **15,000** square feet of net added I impervious area, without regard to total lot impervious area percent, must treat, by means of capture of the first inch of rainfall runoff, an impervious area equal to the net increase of added impervious area. Additionally, the project design must insure there is no increase in the 10-year storm peak flow from the site, and a professional engineer must certify the design.



## What are the exemptions?

Exemptions from Regulated Residential Infill regulation are projects that:

- (1) add less than 800 square feet of net new IA,
- (2) add more than 15,000 square feet of net new IA,
- (3) are on lots larger than one acre where the scope requires a full grading permit, or
- (4) are on lots with a grading permit previously filed with the Metropolitan Water Services (MWS), as long as the post-construction IA conforms to the original grading plan.

### Note:

1. The presence of a grading permit does not automatically result in an exemption. There may be sites that have had a grading permit in the past, but the drainage system is currently inadequate to handle design discharges. The existence of a past grading permit allows the developer to omit use of the one-inch criteria in favor of use of any designed, constructed and maintained competent drainage system already in existence. The developer must still ensure the downstream system is competent to handle the increased discharge. If the system is not competent, the developer may choose to follow normal Tier I, II or III steps, or may choose simply to restore and/or improve the drainage system to handle the increased discharge from the infill site. For Tier III sites detention of the 10-year storm peak flow will still be required.
2. Projects on lots larger than one acre may seek infill classification on a case-by-case basis at the discretion of MWS

## Alternatives to One-Inch Capture

With each Tier classification, there are alternative pathways for the project to meet MWS's infill requirement. The alternatives presented below are not MWS's preference for meeting the requirement of one-inch capture, but are offered to the owner/developer if using the stormwater management practices listed in this document prove to be impractical.

### A) Tier 1 Alternatives

(Net addition of between 800 and 2,500 square feet of impervious area)

1. Demonstrate that an adequate drainage system is present downstream by using the Simple Method described Section D of this document.
2. If an adequate drainage system does not exist downstream, work with MWS and a licensed engineer to devise a solution to improve the drainage downstream to accommodate the increase in flow resulting from the added impervious area.

### B) Tier 2 Alternatives

(Net addition of between 2,500 and 8,000 square feet of impervious area)

1. Demonstrate that an adequate drainage system is present downstream by analyzing the on and off-site drainage for the 10-year peak flow (requires a licensed engineer).
2. If an adequate drainage system does not exist downstream, work with MWS and a licensed engineer to devise a solution to improve the drainage downstream to accommodate the increase in flow resulting from the added impervious area.



C) Tier 3 Alternatives

(Net addition of between 8,000 and 15,000 square feet of impervious area)

1. Demonstrate that an adequate drainage system is present downstream by analyzing the on and off-site drainage for the 10-year peak flow (requires a licensed engineer).
2. If an adequate drainage system does not exist downstream, work with MWS and a licensed engineer to devise a solution to improve the drainage downstream to accommodate the increase in flow resulting from the added impervious area.

**What portions of residential projects require Stormwater Management?**

These requirements intend to capture the main portions of residential impervious areas. Impervious cover is defined as the portion of a parcel of property that is covered by any material, including without limitation roofs, streets, sidewalks and parking lots paved with asphalt, concrete, compacted sand, compacted gravel or clay, that substantially reduces or prevents the infiltration of storm water. Impervious area shall not include natural undisturbed surface rock. Only the major impervious areas of the property need to be treated. This includes the rooftop of the main structure and garage, parking areas and paved patio areas. It excludes minor out buildings, walkways, small miscellaneous paved areas, and the entry driveway area leading from the road to parking and turn around areas.

The area draining to any practice is called the “contributing drainage area” and normally consists of 100% impervious area, though for rain gardens and filter strips incidental small pervious areas can be included if unavoidable, and the areas are stabilized to eliminate soil erosion.

**What are the principles for managing stormwater on residential developments?**

Residential developments are not required to provide the same types of stormwater management as commercial projects; however, certain requirements must be met to ensure that stormwater runoff does not overwhelm stormwater infrastructure; impact water quality in our streams; or impact adjacent property. The key principles for managing stormwater from a residential lot are:

- Proper grading techniques and Erosion Control BMPs during construction;
- Runoff Reduction (see section below);
- Reliance on infiltration only where the water table or bedrock layer is at least two feet below the bottom of the practice in use; and,
- Proper installation and maintenance of downspouts, channels, or any other sources of concentrated flow.



## What is Runoff Reduction?

The term ‘Runoff Reduction’ means the interception, evapotranspiration, infiltration or capture and reuse of stormwater runoff. Examples of runoff reduction techniques on a single-family residential development include any appropriate combination of the following techniques termed Green Infrastructure Practices:

1. installing a rain garden or bioretention area,
2. replacing traditionally impervious surfaces (driveways, patios, etc.) with pervious paving,
3. routing downspouts to underground dry wells,
4. routing downspouts to modified French drains,
5. using cisterns for reuse or irrigation, or
6. directing sheet flow to adequately sized vegetated filter strips, or any appropriate combination of techniques.

The goal of these techniques is to reduce the volume of runoff generated by the first one-inch of rainfall runoff.

## How are Runoff Reduction techniques sized on residential developments?

The amount of volume to be reduced on site is directly related to the drainage area contributing runoff to the treatment technology.

## What needs to be submitted?

Applicants must develop a site plan using the checklist available in the Development Services Center. The checklist items relevant to stormwater management include the following:

- Location, configuration and finished elevations for existing and proposed impervious areas;
- Proposed drainage infrastructure in ROW
- Lot/building layout with dimensions;
- Existing and proposed ground contours and elevations;
- Sanitary and storm sewer, structures and easements;
- Erosion and sediment control practices in conformance with the Stormwater Management Manual Volume 4;
- Selected Green Infrastructure Control & Practice Tear Sheets
- All points where stormwater leaves the site (if applicable);
- Locations of buffer (stream, floodway) zones (if applicable);
- 100-year floodplain boundary (if applicable);
- Proof of zero increase in 10-year peak runoff (if applicable);
- Proof of competent downstream drainage (if applicable); and
- Previously assigned grading permit (if applicable).



### What is in the rest of this document?

The remainder of the document contains:

**Section II** - A set of six information/specification sheets, one for each of the six Green Infrastructure Controls recommended for use. For each, the last two pages are a tear-off set of specifications that can be filled in and stapled to construction plans.

**Section III** - Describes how the preservation of trees can be credited.

**Section IV** - Describes how to conduct infiltration testing.

**Section V** - Describes the types of vegetation recommended for use for those Controls that feature vegetation as part of the treatment approach.

**Section VI** - Describes the simple method to determine adequate drainage for Tier I infill projects.

**Section VII** – Declaration of Restrictions and Covenants for the storm water control measures utilized with Regulated Residential Infill

**Section VIII** – Long Term Control Plan for Regulated Residential Infill SCMs



*This page left blank intentionally*



## II. GREEN INFRASTRUCTURE CONTROLS

### A. CISTERN

Cisterns are low impact development practices that store rainwater for later use. Rain is collected from a downspout system, screened to remove trash and leaves and conveyed to a storage container for subsequent use. Unless an advanced filtration system is used, water stored in the cistern is for non-potable water use only. If properly sized, they can provide significant reductions in stormwater runoff rates, volumes and pollutant loads from residential sites. Rain barrels may be part of an overall stormwater management system; however, by themselves they may not be sufficient to meet the requirements of this ordinance.



1,500 Gallon Cistern  
Source: LID Urban Design Tools

#### LOCATION

- Consider the size of the contributing drainage areas, and projected water needs, to determine how large a storage tank is needed. Cisterns should drain only impervious areas – preferably rooftops.
- Pick a location keeping in mind: (1) ease in connecting roof drains, (2) overflow to downslope areas, (3) level area, (4) location relative to intended water uses, (5) other utility conflicts, (6) electrical connections if applicable, (7) residential emergency ingress/egress, (8) leaf screen option,
- (9) location of hoses or other water distribution components, and (10) aesthetic considerations.

#### DESIGN

- To fully meet the Metro Nashville standard, cistern capacity must be designed for a 1 inch storm. A good rule of thumb is that when sizing a cistern for the one inch rain standard, each square foot of rooftop will contribute 0.6 gallons of runoff. A one-hundred square foot roof surface will fill a 55 gallon barrel.
- Cisterns come in sizes from a 55 gallon rain barrel to a 1,500 gallon cistern. If the cistern cannot hold the full inch one alternative is to divert overflow to another low impact development structure such as a filter strip, or rain garden.
- Measure contributing roof area width from the drip line of the overhang to the roof peak ignoring the slant, and the length. The width times the length in feet is the drainage area. Multiply that by 0.6 gallons and that is the size of the cistern you will need to fully meet the one-inch rainfall standard.
- All holding tanks should be opaque to prevent algae growth.
- Pretreatment of water entering the cistern will remove debris, dust, leaves, and other material. Pretreatment options are illustrated on the specification sheet. One or more options should be chosen.
- The cistern should have an overflow pipe so that when





the tank reaches capacity, the rainwater will be directed away from adjacent buildings. More than one cistern can be linked to increase storage capacity.

- Drainage system components leading to the cistern should have a minimum slope of 2% for gravity drainage to the cistern.
- For more complex designs a rainwater-harvesting model is provided by the North Carolina State University at <http://www.bae.ncsu.edu/topic/waterharvesting>.
- Gravity feed drip irrigation kits are available from several suppliers as well as complete instructions how to design an irrigation system for the low pressure of a cistern system without a pump.

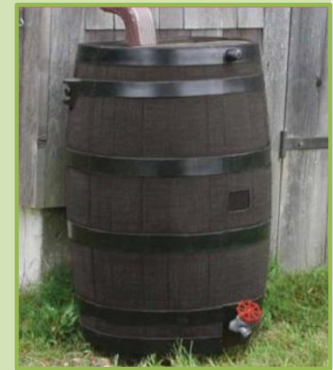

Example Rain Barrel

## MAINTAIN

- To maintain the storage capacity of the cistern rainwater should be used regularly and a draw down plan initiated.
- Routine checks of the intake and leaf screening components should be done once in the spring and periodically during the fall if leaves fall on the contributing roof area.
- Insure mosquito screen is tight.
- Inspect and if necessary clean out tank annually by scrubbing and letting water drain through low flow plug.
- Check connections for leaks; and inspect overflow for erosion.



Example Linked Cisterns  
Source: <http://www.djc.com>

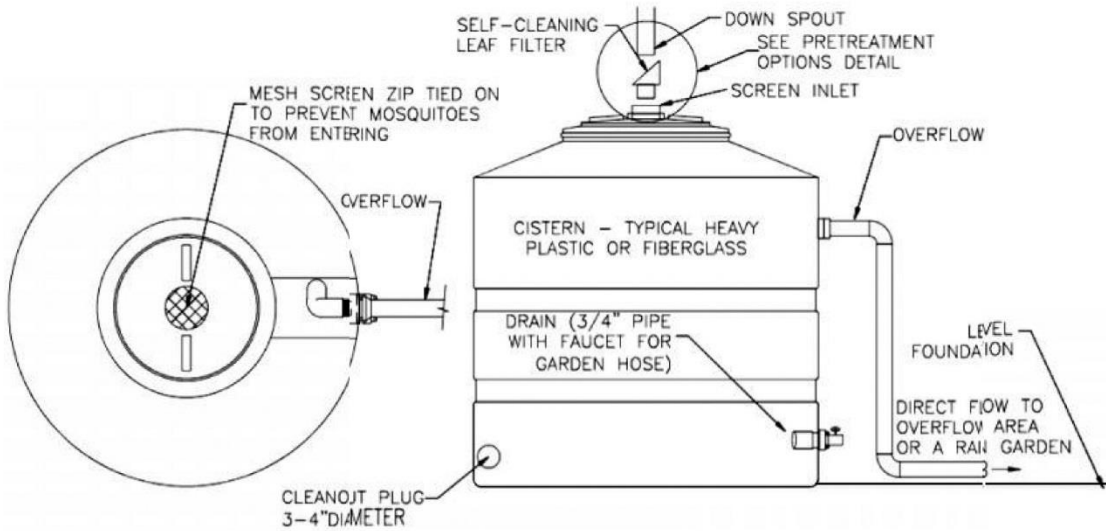

TYPICAL COMPONENTS (ATTACH MANUFACTURER'S SPECIFICATIONS)

CONSTRUCTION STEPS:

1. Locate cistern for: (1) ease in connecting roof drains, (2) overflow to downslope area, (3) level area, (4) location relative to intended water uses, (5) other utility conflicts, (6) electrical connections if applicable, (7) emergency ingress/egress, (8) leaf screen option, (9) location of hoses or other water distribution components, and (10) aesthetic considerations.
2. Depending on use review and follow applicable plumbing code.
3. Provide level foundation of compacted earth, blocks, gravel or other hard long-lasting surface.
4. Place cistern tank and review all connections for layout and sizing.
5. Cut and route downspouts or other rainwater delivery components, leaf screen option(s) chosen (circle selected options in Pretreatment Options Detail figure), and mosquito screen as applicable. Strap and support as needed.
6. Install water outlet connections including pumps as applicable. Follow manufacturer's specification for all connections and fittings including inlet, overflow, and clean out.
7. Extend overflow to adequate non-eroding discharge point no less than 10 feet from any common property line.
8. Test cistern by filling with water and testing all components in turn – including spraying water on the roof and observing flow.
9. Consider appearance and final landscaping and screening. Complete construction, landscaping, etc.

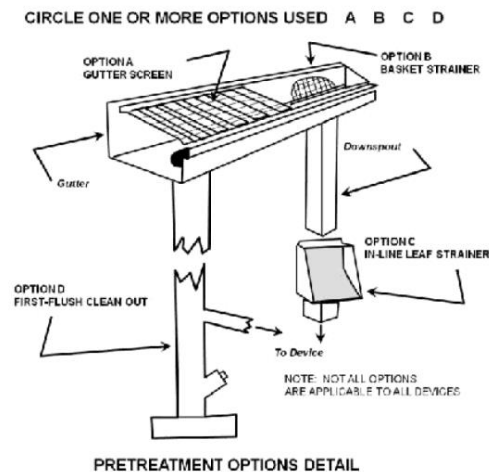

<p>METRO NASHVILLE          DEPARTMENT OF          WATER SERVICES</p>	<p>NAME/ADDRESS:</p>	<p>CISTERN          SPECIFICATIONS PAGE          1 OF 2</p>
---	----------------------	---



**SKETCH LAYOUT**

PROVIDE PLAN AND ELEVATION VIEWS OF CISTERN AND HOUSE SHOWING ROOF AREA DIRECTED TO CISTERN AND KEY DIMENSIONS AND CONNECTIONS AND OVERFLOW RELATIVE TO PROPERTY LINE.

**NOTES:**  
 1. ATTACH MANUFACTURER'S SPECIFICATIONS AND OTHER DETAILS

<p><b>SIZING CALCULATION:</b></p> <p>0.6 GALLONS * SQ FT OF ROOF AREA DIRECTED TO CISTERN</p> <p>ROOF AREA DIRECTED TO CISTERN= _____ SQ FT          CISTERN SIZE= _____ GAL</p> <p>TYPE OF CISTERN/MANUFACTURER:          _____</p>	<p><b>MAINTENANCE:</b></p> <ol style="list-style-type: none"> <li>1. TO MAINTAIN THE STORAGE CAPACITY OF THE CISTERN RAINWATER SHOULD BE USED REGULARLY</li> <li>2. ROUTINE CHECKS OF THE INTAKE AND LEAF SCREENING COMPONENTS SHOULD BE DONE ONCE IN THE SPRING AND PERIODICALLY DURING THE FALL IF LEAVES FALL ON THE CONTRIBUTING ROOF AREA.</li> <li>3. INSPECT AND IF NECESSARY CLEAN OUT TANK ANNUALLY BY SCRUBBING AND LETTING WATER DRAIN THROUGH LOW FLOW PLUG. CHECK CONNECTIONS FOR LEAKS; AND INSPECT OVERFLOW FOR EROSION.</li> </ol>
--	--

METRO NASHVILLE DEPARTMENT OF WATER SERVICES	ATTACHED THIS TWO-PAGE SPECIFICATION TO HOUSE PLAN SUBMITTAL	CISTERN SPECIFICATIONS PAGE 2 OF 2
--	--	---------------------------------------



## B. DRY WELL

Dry wells are comprised of seepage tanks set in the ground and surrounded with stone that are designed to intercept and temporarily store stormwater runoff until it infiltrates into the soil. Alternately the pit can be filled with stone with water entering via a perforated pipe with a perforated standpipe in place of the tank.

Dry wells are particularly well suited to receive rooftop runoff entering the tank via an inlet grate (shown right) or direct downspout connection (below right). When properly sized and laid out dry wells can provide significant reductions in stormwater runoff and pollutant loads.

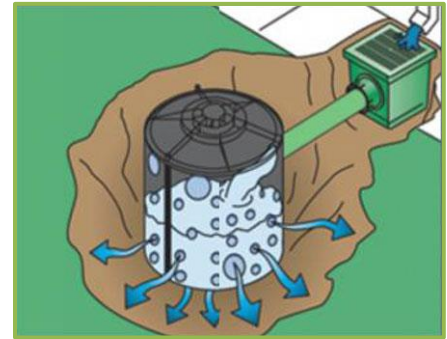

Source: [www.earthcontactproducts.com](http://www.earthcontactproducts.com)

### LOCATION

- Dry wells must be located at least 10 feet from building foundations and 10 feet from property lines.
- To reduce the chance of clogging, dry wells should drain only impervious areas, and runoff should be pretreated with at least one of the leaf removal options to remove debris and larger particles.
- The height of the tank should not exceed 45 inches unless infiltration testing has been done to insure a drain time of 72 hours or less.
- Dry wells should be located in a lawn or other pervious (unpaved) area and should be designed so that the top of the dry well is located as close to the surface as possible.
- Dry wells should not be located: (1) beneath an impervious (paved) surface; (2) above an area with a water table or bedrock less than two feet below the trench bottom; (3) over other utility lines; or, (4) above a septic field. Always call 811 to locate utility lines before you dig.



### CONSTRUCTION

- Consider the drainage area size and the soil infiltration rate when determining the size of the dry well, (see table on next page).
- The sides of the excavation should be trimmed of all large roots that will hamper the installation of the permeable drainage fabric used to line the sides and top of the dry well.
- The dry well hole should be excavated 1 foot deeper and two feet larger in diameter than the well to allow for a 12 inch stone fill jacket.
- The native soils along the bottom of the dry well should be scarified or tilled to a depth of 3 to 4 inches.
- Fill below and around dry well approximately 12 inches of clean, washed #57 stone. #57 stone averages ½ inch to 1-1/2 inches.
- Fill the final 6 inches of the excavation with native soil.
- Optionally pea gravel or #8 stone can be carried to the surface.
- For rooftop runoff, install a leaf screen in the gutter or down spout prior to entering the dry well to prevent leaves and other large debris from clogging the dry well. For non-rooftop runoff,



precede dry well with an in ground sump grate inlet leaf trap.

- An overflow, such as a vegetated filter strip or grass channel, should be designed to convey the stormwater runoff generated by larger storm events safely bypassing the dry well.
- The optional design involves placement of a vertical standpipe connected to the inlet pipe. See figure below.

The table below can be used to size a dry well system. Given the tank height and diameter the contributing drainage area in square feet treated can be read. For example, if a 10 by 50-foot roof is to be treated the total roof area is 10\*50 = 500 square feet. This could be handled by one tank 60" high, 30" diameter. It can also be handled by two tanks 30" high and 24" in diameter.

If you elect to measure infiltration rate and find it is higher than 0.5 in/hr length of the dry well size can be reduced. For every 0.5 in/hr increase in measured infiltration rate above 0.5 in/hr subtract ten percent of the required dry well size as measured in square feet captured.

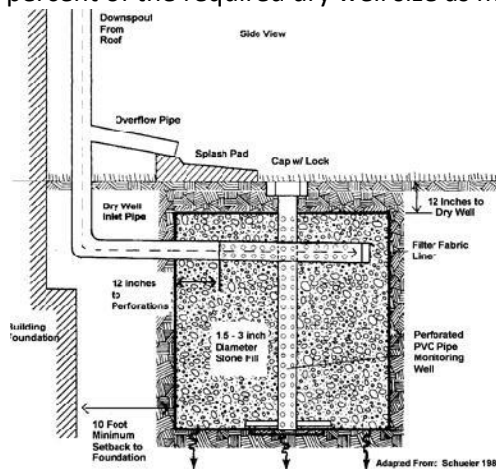

Gravel Bed Depth (inches)	Tank Height (inches)	Tank Inside Diameter (inches)				
		24	30	36	42	48
Contributing Area Captured (square feet)						
6	30	258	345	447	563	692
12	30	285	380	490	615	755
6	60	461	622	809	1022	1263
12	60	489	657	852	1075	1325

Hole Depth (inches)	6" Perforated Standpipe Gravel Filled Hole Diameter (inches)				
	24	30	36	42	48
Contributing Area Captured (square feet)					
24	30	46	65	88	114
30	38	58	82	110	142
36	46	69	98	132	171
42	53	81	114	154	199
48	61	92	130	176	228
60	76	115	163	219	285

## VEGETATION

- The landscaped area above the surface of a dry well should be covered with pea gravel when water enters a dry well through surface features rather than the pipe. This pea gravel layer provides sediment removal and additional pretreatment upstream of the dry well and can be easily removed and replaced when it becomes clogged.
- Alternatively, a dry well may be covered with an engineered soil mix and planted with managed turf or other herbaceous vegetation.

## MAINTENANCE

Annual maintenance is important for dry wells, particularly in terms of ensuring that they continue to provide measurable stormwater management benefits over time.

- Inspect gutters and downspouts removing accumulated leaves and debris.
- Inspect dry well following rainfall events.
- If applicable, inspect pretreatment devices for sediment accumulation. Remove accumulated trash and debris.
- Inspect top layer of filter fabric for sediment accumulation. Remove and replace if clogged.

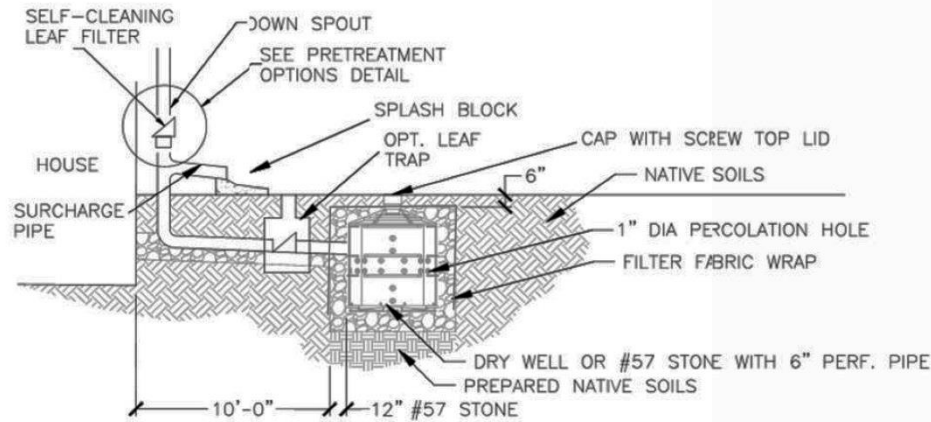

TYPICAL COMPONENTS (ATTACH MANUFACTURER'S SPECIFICATIONS)  
 CONSTRUCTION STEPS:

1. Review potential dry well areas and layout. Dry wells should not be located: (1) beneath an impervious (paved) surface; (2) above an area with a water table or bedrock less than two feet below the trench bottom; (3) over other utility lines; or, (4) above a septic field. Insure outlet daylights at least ten feet from property line.
2. Measure the area draining to the dry well and determine required size from the table on the next page.
3. If soil is a concern perform infiltration test according to Section B. If the rate is less than 0.25 in/hr this method cannot be used. If the rate is more than 0.50 in/hr the storage volume may be decreased 10% for every 0.50 in/hr infiltration rate increase above 0.50 in/hr.
4. Measure elevations and dig the hole to the required dimensions. Scarify the bottom soil surface 3".
5. Place and tamp 6" to 12" of #57 gravel in bottom. Pea gravel can be substituted for leveling purposes in the upper three-inch layer below the tank.
6. Place and secure filter cloth down sides of the excavation leaving enough to fold over the top below the soil and turf.
7. Place tank and install piping. Bond top of tank in place.
8. Cut and route downspouts or other rainwater delivery components, leaf screen option(s) chosen (circle selected options in Pretreatment Options Detail figure). Strap and support as needed.
9. Create a safe overflow at least 10 feet from your property edge and insure it is protected from erosion.
10. Test connections with water flow.
11. Fill with gravel jacket around tank and place permeable fabric above between gravel and soil.
12. Backfill with soil/sod or pea gravel.
13. Consider aesthetics as appropriate and erosion control for overflow.

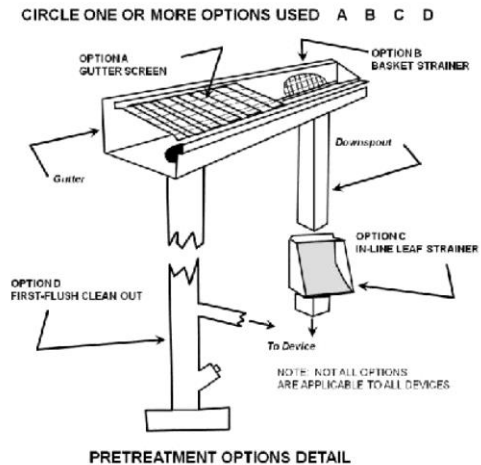

METRO NASHVILLE DEPARTMENT OF WATER SERVICES	NAME/ADDRESS:	DRY WELL SPECIFICATIONS PAGE 1 OF 2
--	---------------	--



**SKETCH LAYOUT**

PROVIDE PLAN AND ELEVATION VIEWS OF DRY WELL AND HOUSE SHOWING ROOF AREA DIRECTED TO DRY WELL AND KEY DIMENSIONS, CONNECTIONS AND OVERFLOW RELATIVE TO PROPERTY LINE.

<p><b>SIZING</b></p> <table border="1" style="width: 100%; border-collapse: collapse; text-align: center;"> <thead> <tr> <th rowspan="2">Gravel Bed Depth (inches)</th> <th rowspan="2">Tank Height (inches)</th> <th colspan="5">Tank Inside Diameter (inches)</th> </tr> <tr> <th>24</th> <th>30</th> <th>36</th> <th>42</th> <th>48</th> </tr> </thead> <tbody> <tr> <td colspan="7"><b>Contributing Area Captured (square feet)</b></td> </tr> <tr> <td>6</td> <td>30</td> <td>258</td> <td>345</td> <td>447</td> <td>563</td> <td>692</td> </tr> <tr> <td>12</td> <td>30</td> <td>285</td> <td>380</td> <td>490</td> <td>615</td> <td>755</td> </tr> <tr> <td>6</td> <td>60</td> <td>461</td> <td>622</td> <td>809</td> <td>1022</td> <td>1263</td> </tr> <tr> <td>12</td> <td>60</td> <td>489</td> <td>657</td> <td>852</td> <td>1075</td> <td>1325</td> </tr> </tbody> </table> <table border="1" style="width: 100%; border-collapse: collapse; text-align: center;"> <thead> <tr> <th rowspan="2">Hole Depth (inches)</th> <th colspan="5">6" Perforated Standpipe Gravel Filled Hole Diameter (inches)</th> </tr> <tr> <th>24</th> <th>30</th> <th>36</th> <th>42</th> <th>48</th> </tr> </thead> <tbody> <tr> <td colspan="6"><b>Contributing Area Captured (square feet)</b></td> </tr> <tr> <td>24</td> <td>30</td> <td>46</td> <td>65</td> <td>88</td> <td>114</td> </tr> <tr> <td>30</td> <td>38</td> <td>58</td> <td>82</td> <td>110</td> <td>142</td> </tr> <tr> <td>36</td> <td>46</td> <td>69</td> <td>98</td> <td>132</td> <td>171</td> </tr> <tr> <td>42</td> <td>53</td> <td>81</td> <td>114</td> <td>154</td> <td>199</td> </tr> <tr> <td>48</td> <td>61</td> <td>92</td> <td>130</td> <td>176</td> <td>228</td> </tr> <tr> <td>60</td> <td>76</td> <td>115</td> <td>163</td> <td>219</td> <td>285</td> </tr> </tbody> </table> <p>MEASURE CONTRIBUTING DRAINAGE AREA AND READ AREA FOR GIVEN MEDIA DEPTH.</p> <p>CONTRIBUTING DRAINAGE AREA= _____ SQ FT        TANK DIAMETER= _____ INCHES        TANK HEIGHT= _____ INCHES        GRAVEL BED DEPTH= _____ (6 OR 12 INCHES)        ALTERNATIVE STANDPIPE DESIGN        HOLE DIAMETER= _____ INCHES        HOLE DEPTH= _____ INCHES</p>	Gravel Bed Depth (inches)	Tank Height (inches)	Tank Inside Diameter (inches)					24	30	36	42	48	<b>Contributing Area Captured (square feet)</b>							6	30	258	345	447	563	692	12	30	285	380	490	615	755	6	60	461	622	809	1022	1263	12	60	489	657	852	1075	1325	Hole Depth (inches)	6" Perforated Standpipe Gravel Filled Hole Diameter (inches)					24	30	36	42	48	<b>Contributing Area Captured (square feet)</b>						24	30	46	65	88	114	30	38	58	82	110	142	36	46	69	98	132	171	42	53	81	114	154	199	48	61	92	130	176	228	60	76	115	163	219	285	<p><b>CALCULATION:</b></p>	<p><b>MAINTENANCE:</b></p> <ol style="list-style-type: none"> <li>1. INSPECT GUTTERS AND DOWNSPOUTS REMOVING ACCUMULATED LEAVES AND DEBRIS, CLEANING LEAF REMOVAL SYSTEM(S).</li> <li>2. IF APPLICABLE, INSPECT PRETREATMENT DEVICES FOR SEDIMENT ACCUMULATION. REMOVE ACCUMULATED TRASH AND DEBRIS.</li> <li>3. INSPECT DRY WELL FOLLOWING A LARGE RAINFALL EVENT TO ENSURE OVERFLOW IS OPERATING AND FLOW IS NOT CAUSING PROBLEMS.</li> </ol>
Gravel Bed Depth (inches)			Tank Height (inches)	Tank Inside Diameter (inches)																																																																																																		
	24	30		36	42	48																																																																																																
<b>Contributing Area Captured (square feet)</b>																																																																																																						
6	30	258	345	447	563	692																																																																																																
12	30	285	380	490	615	755																																																																																																
6	60	461	622	809	1022	1263																																																																																																
12	60	489	657	852	1075	1325																																																																																																
Hole Depth (inches)	6" Perforated Standpipe Gravel Filled Hole Diameter (inches)																																																																																																					
	24	30	36	42	48																																																																																																	
<b>Contributing Area Captured (square feet)</b>																																																																																																						
24	30	46	65	88	114																																																																																																	
30	38	58	82	110	142																																																																																																	
36	46	69	98	132	171																																																																																																	
42	53	81	114	154	199																																																																																																	
48	61	92	130	176	228																																																																																																	
60	76	115	163	219	285																																																																																																	

METRO NASHVILLE DEPARTMENT OF WATER SERVICES	ATTACHED THIS TWO- PAGE SPECIFICATION TO HOUSE PLAN SUBMITTAL	DRY WELL SPECIFICATIONS PAGE 2 OF 2
--	---	--



## C. VEGETATED FILTER STRIPS

A vegetated filter strip can be an attractive and functional addition to your home landscape. Vegetated filter strips (also known as grass filters) are uniformly graded, vegetated areas of land designed to receive rainwater as sheet flow and slow and filter stormwater runoff from roof downspouts or parking areas. Vegetated filter strips can provide significant reductions in stormwater runoff and pollutant loads in your local watershed.



### LOCATION

- Take note of the drainage patterns to determine the best location for a vegetated filter strip. Assess the drainage area flow paths on your property, and the slope of the drainage area. Ideal locations are places where there is a gentle slope away from the structure or paved area, the area is relatively flat, and where the flow can be evenly dispersed along the top of the filter area.
- The ideal slope of the vegetated filter strip is between 1 and 5%. Greater slopes would encourage the formation of concentrated flow within the filter strip, while lesser slopes would encourage unplanned ponding. If the slope is greater, terracing can be used with level spreaders between each terrace.
- Placing a filter strip over utilities is acceptable except where the amended soil option is used. In that case ensure utility locations are noted and care is taken in soil amendment actions. Amended or bermed filter strips should not be placed over a septic field.
- The length of the vegetated filter strip should be no less than 25 feet. If there is a permeable berm at the lower end, the length of the vegetated filter strip should be no less than 15 feet. Natural forested areas on site can be counted in the filter strip length total.
- The surface impervious area to any one discharge location cannot exceed 5,000 square feet.

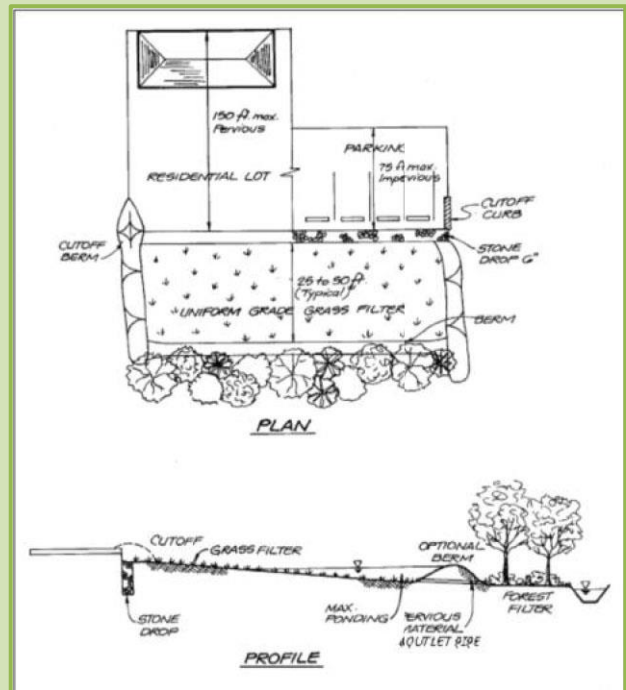

Source:  
Center for Watershed Protection. 2009.  
Coastal Stormwater Supplement to the  
Georgia Stormwater Management Manual.

### CONSTRUCTION

#### Level Spreader

- A level spreader must be used at the upstream end of the filter strip to evenly distribute stormwater runoff. A level spreader is a small trench filled with pea gravel or # 8 stone installed along a level contour.
- The level spreader should be 12' to 18" wide and 6" to 12" deep depending on the amount of expected flow. Larger diameter stone may be required to stabilize entry points for larger



contributing impervious areas.

- To help insure more even discharge of flow into the filter strip, notches can be cut in the level spreader at intervals allowing overflowing water to enter at several locations ahead of general overflow.
- The level spreader can be connected to the downspout through a T-connection to perforated pipes embedded in the flow spreader trench (see figure).
- Ensure the overflow points are protected from erosion and not blocked by vegetation.
- If the impervious drainage area to any one entry point (e.g., a downspout) is less than 1,000 square feet appropriate level spreaders may be waived if flow will flow as a sheet through the strip area. In this case simple splash blocks (see figure) can be used to introduce flow into turf (yard) areas.

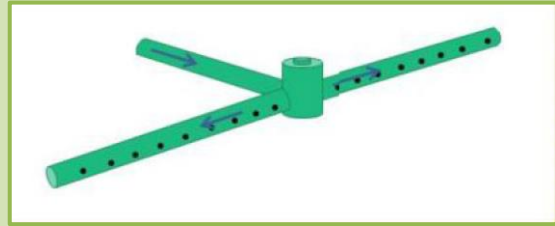

**Amended Soil Design Option**

- Increased infiltration and a doubling of the ability to meet the one-inch standard can be achieved by amending the soil within the filter strip by tilling the existing soil 12” deep and mixing 4” of compost.

**Berm Design Option**

- A greater ability to meet the one-inch standard can be achieved through the use of a permeable berm at the bottom end of the filter strip. The permeable berm is used to temporarily store stormwater runoff within the filter strip, which increases the infiltration and reduces the required width of the filter strip.
- Permeable berms should be constructed of well drained soils (sand, gravels, and sandy loams) that support plant growth and should be no more than 12” high.
- Appropriately sized outlets should be provided within permeable berms to ensure that vegetated filter strips will drain within 24 hours following the end of a rainfall event.
- A stone-protected overflow area through the berm may be used to manage the stormwater runoff generated by large storm events.

Contributing Drainage Area (square feet)	Filter Strip Type		
	Conventional	Amended Soil	Berm
	Filter Strip Area (sq ft)		
100	200	70	50
500	1000	350	250
1000	2000	670	500
2000	4000	1400	1000
3000	6000	2700	1500
4000	8000	5400	2000
5000	10000	6700	2500

The overflow point must be at least ten feet from the property line if flow is onto adjoining property. Erosion protection is critical.

**Design Table**

Measure the rooftop and any other area that is going to be directed to the filter strip. From the site layout select the size and type of filter strip from the table to meet the one-inch design standard. For example, for a 1,000 square foot rooftop conventional filter strip the filter strip surface area must be at least 2,000 square feet with a minimum flow length of 25 feet. Built with a berm it can have a surface area of 500 square feet and have a minimum flow length of 15 feet.



---

## VEGETATION

- Vegetation commonly planted on vegetated filter strips includes turf, shrubs, trees, and other herbaceous vegetation.
- Choose grasses and other vegetation that will be able to tolerate the stormwater runoff rates and volumes that will pass through the vegetated filter strip.
- Vegetation used in filter strips should be able to tolerate both wet and dry conditions.
- Refer elsewhere within this document for more guidance.

---

## MAINTENANCE

- Maintain the vegetated filter strip so that it will continue to provide measurable stormwater management benefits over time.
- Water as needed to promote plant growth and survival especially in the first two seasons.
- Provide normal turf or garden maintenance - mow, prune, and trim as needed.
- Inspect the vegetated filter strip following rainfall events. Fix erosion issues immediately.
- Remove accumulated trash, sediment and debris.

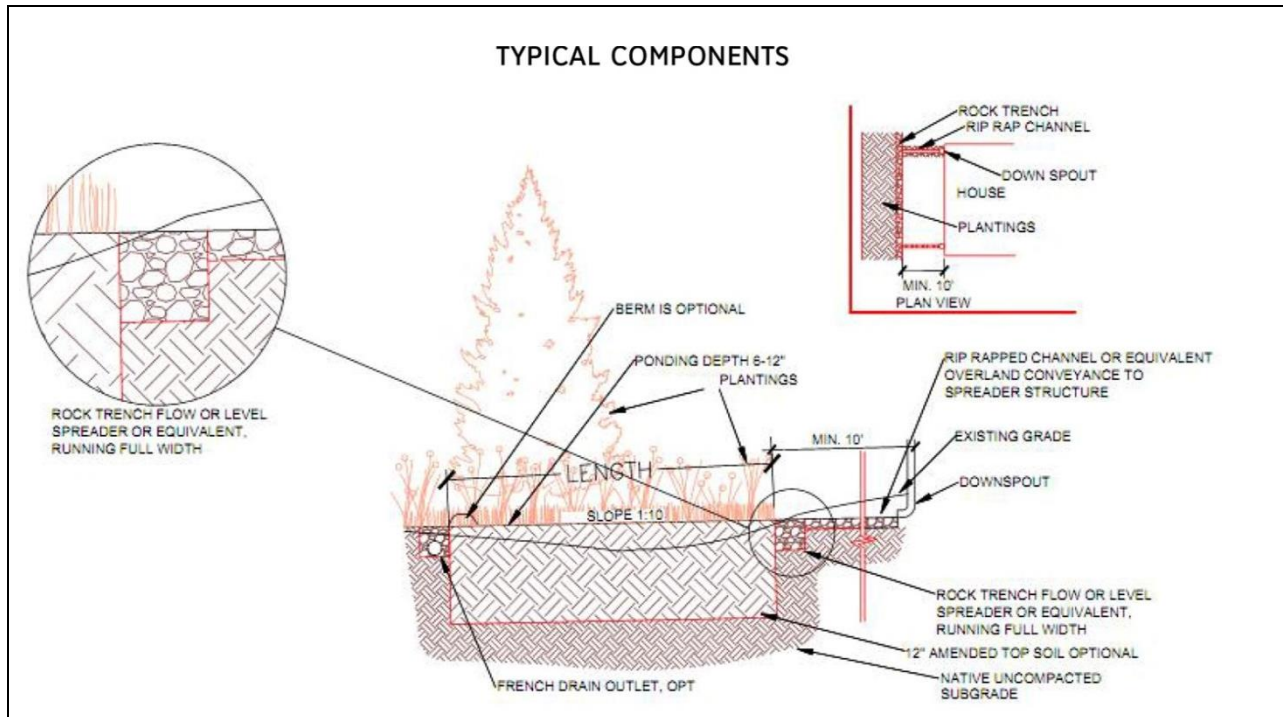

**CONSTRUCTION STEPS:**

1. Review potential filter strip areas and layout. Filter strips should slope between 1% and 5% away from the structure and should not be located above a septic field. Placing a filter strip over utilities is acceptable except where the amended soil option is used. In that case ensure utility locations are noted and care is taken in soil amendment actions. If there is a concentrated overflow insure it is at least ten feet from adjacent property.
2. Measure the area draining to the filter strip and determine required surface area and minimum length from the table on the next page. Determine the desired filter strip and flow spreader options.
3. Lay out and mark filter strip area, flow spreader line and inlets.
4. Construct flow spreader filling trench with appropriate gravel and noting overflow points.
5. Construct filter strip option, prepare soil.
6. Construct erosion control at the flow entrance and exit points as applicable.
7. Plant dense vegetation according to plan, or sod/seed. Ensure an irrigation plan is in place.
8. Ensure temporary erosion control is in place as needed until vegetation establishment.

METRO NASHVILLE DEPARTMENT OF WATER SERVICES	NAME/ADDRESS:	FILTER STRIP SPECIFICATIONS PAGE 1 OF 2
--	---------------	--



**SKETCH LAYOUT**

PROVIDE PLAN AND ELEVATION VIEWS OF FILTER STRIP AND HOUSE SHOWING ROOF AREA DIRECTED TO FILTER STRIP AND KEY DIMENSIONS, CONNECTIONS AND OVERFLOW RELATIVE TO PROPERTY LINE.

**SIZING CALCULATION:**

Contributing Drainage Area (square feet)	Filter Strip Type		
	Conventional	Amended Soil	Berm
	Filter Strip Area (sq ft)		
100	200	70	50
500	1000	350	250
1000	2000	570	500
2000	4000	1400	1000
3000	6000	2700	1500
4000	8000	5400	2000
5000	10000	6700	2500

MEASURE CONTRIBUTING DRAINAGE AREA AND READ AREA FOR GIVEN FILTER TYPE.

CONTRIBUTING DRAINAGE AREA= \_\_\_\_\_ SQ FT  
 FILTER STRIP AREA= \_\_\_\_\_ SQ FT  
 CONVENTIONAL – 25' MINIMUM LENGTH  
 BERM OPTION – 15' MINIMUM LENGTH

- MAINTENANCE:**
1. INSPECT GUTTERS AND DOWNSPOUTS REMOVING ACCUMULATED LEAVES AND DEBRIS, CLEANING LEAF REMOVAL SYSTEM(S).
  2. IF APPLICABLE, INSPECT PRETREATMENT DEVICES FOR SEDIMENT ACCUMULATION. REMOVE ACCUMULATED TRASH AND DEBRIS.
  3. WATER AS NEEDED TO PROMOTE PLANT GROWTH AND SURVIVAL ESPECIALLY IN THE FIRST TWO SEASONS.
  4. PROVIDE NORMAL TURF OR GARDEN MAINTENANCE - MOW, PRUNE, AND TRIM AS NEEDED.
  5. INSPECT THE VEGETATED FILTER STRIP FOLLOWING RAINFALL EVENTS. FIX EROSION ISSUES IMMEDIATELY.

METRO NASHVILLE  
 DEPARTMENT OF  
 WATER SERVICES

ATTACHED THIS TWO-PAGE  
 SPECIFICATION TO HOUSE  
 PLAN SUBMITTAL

FILTER STRIP  
 SPECIFICATIONS  
 PAGE 2 OF 2



*This page left blank intentionally*



## D. MODIFIED FRENCH DRAIN

Modified French Drains (MFD) are shallow trench excavations filled with stone that are designed to intercept and temporarily store stormwater runoff until it infiltrates into the soil. MFDs can provide significant reductions in stormwater runoff and pollutant loads. They are particularly well suited to receive rooftop runoff, but can also be used to receive stormwater runoff from other small impervious areas. In Nashville only the daylighted French Drain version is allowed in residential applications. The perforated pipe is daylighted at its end allowing for overflow of larger storms and a failsafe mechanism should infiltration not be as anticipated.



### LOCATION

- MFD trenches should be located at least 5 feet from building foundations and 10 feet from buildings with basements and property lines. The top end of the MFD can be adjacent to the building to connect downspouts but should be directed away from the structure.
- MFDs should slope away from the structures. The slope of the MFD pipe should be between 0.5% and 6%. It can be serpentine or multi-pronged in construction if sufficient slope is available.
- To reduce the chance of clogging, MFDs should drain only impervious areas, and runoff should be pretreated with at least one of the leaf removal options to remove debris and larger particles.
- MFD gravel depths should be at least 18 inches and no more than 36 inches.
- MFDs should be located in a lawn or other pervious (unpaved) area and should be designed so that the top of the MFD is located as close to the surface as possible to reduce digging.
- MFDs should not be located: (1) beneath an impervious (paved) surface; (2) above an area with a water table or bedrock less than two feet below the trench bottom; (3) over other utility lines; or, (4) above a septic field. Always call 811 to locate utility lines before you dig.
- The downstream end of the pipe must daylight for overflows more than ten feet from the property line.
- The desirable soil infiltration rate suitable for a MFD is 0.50 inches per hour (in/hr) or greater. If there is concern due to tight soils when digging, an infiltration test should be done as per Section B.

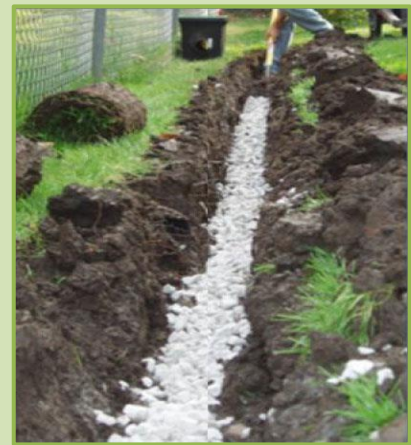



## CONSTRUCTION

- As a rule-of-thumb there should be about 23 cubic feet of stone for every 100 square feet of rooftop. The table provides MFD length requirements for different depths.
- The assumed width in the table is 24 inches. The width can be from 18 to 32 inches. Required lengths should be adjusted proportionately if other widths are used.
- The sides of the excavation should be trimmed of all large roots that will hamper the installation of the permeable drainage fabric used part way down the sides and above the gravel layer on top of the MFD.
- The native soils along the bottom of the MFD should be scarified or tilled to a depth of 3 to 4 inches.
- Fill the MFD with clean, washed #57 stone embedding a six inch diameter perforated pipe in the top of the stone such that the stone covers the top of the pipe. #57 stone averages ½ inch to 1-1/2 inches.
- The pipe should have 3/8 inch perforations, spaced 6 inches on center, and have a minimum slope of 0.5% and a maximum slope of 6%.
- The perforated pipe must daylight at the downstream end of the trench.
- An overflow, such as a vegetated filter strip or grass channel, should be designed to convey the stormwater runoff generated by larger storm events safely out of the downstream end of the MFD.
- Place permeable landscape fabric over gravel to keep soil or pea gravel from migrating into the gravel and filling the pore spaces, and leave four to six inches above the pipe to the ground surface.
- Cover with top soil and sod or with pea gravel.
- For rooftop runoff, install one or more leaf screen options prior to entering the MFD to prevent leaves and other large debris from clogging the MFD. For driveway or parking runoff a screened inlet grate over a sump or pea gravel pit can be used to settle out material prior to entering the pipe.

Rooftop Area (square feet)	Depth of Gravel From Top of Pipe (inches)			
	18	24	30	36
	Required Linear Feet of MFD			
100	6	5	4	3
500	30	25	20	15
1000	60	45	40	35
2000	120	95	75	65
3000	185	140	115	100
4000	245	190	155	130
5000	305	235	195	165

## VEGETATION

- A MFD is normally covered with topsoil and managed turf or other herbaceous vegetation.
- As an alternative, the area above the surface of a MFD may be covered with pea gravel (or larger depending on the inflow rates) to allow for incidental lateral inflow along the edge of ground level impervious surfaces.
- The downstream end of the pipe must be stabilized and can be landscaped for aesthetics.

## MAINTENANCE

Annual maintenance is important for MFDs.

- Inspect gutters/downspouts removing accumulated leaves and debris, cleaning leaf removal system(s).
- Inspect any pretreatment devices for sediment accumulation. Remove accumulated trash and debris.
- Inspect MFD following a large rainfall event to ensure overflow is operating and flow is not causing problems.

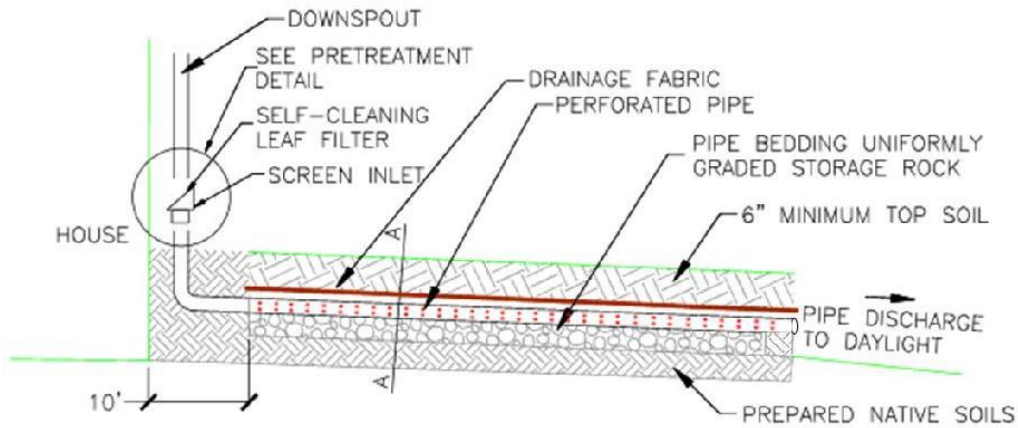

**CONSTRUCTION STEPS:**

1. Review potential MFD areas and layout. MFDs should slope between 0.5% and 6% away from the structure and should not be located: (1) beneath an impervious (paved) surface; (2) above an area with a water table or bedrock less than two feet below the trench bottom; (3) over other utility lines; or, (4) above a septic field. Insure outlet daylights at least ten feet from property line.
2. Measure the area draining to the MFD and determine required length from the table on the next page using assumed width and gravel depth, and plan route and excavation depth.
3. If soil is a concern, perform infiltration test according to Section B. If the rate is less than 0.25 in/hr this method cannot be used. If the rate is more than 0.50 in/hr the length of the ditch may be decreased 10% for every 0.50 in/hr infiltration rate increase above 0.50 in/hr.
4. Measure elevations and lay out the MFD to the required dimensions marking the route and required excavation depths. Often a level line (torpedo level) is used.
5. Remove sod using a sod cutter if appropriate. Excavate ditch to the depth of the gravel plus six inches for topsoil/pea gravel and three additional inches to accommodate half the pipe depth. Be careful not to compact soils in the bottom. Level the bottom laterally as much as possible to maximize infiltration area. Roughen bottom to a depth of at least three inches and trim roots.
6. Place and tamp gravel in ditch to planned depth placing the pipe three inches deep in the upper portion of the gravel. Then place and gently tamp gravel until it covers the pipe.
7. Place drainage fabric over top of pipe and stone.
8. Place topsoil and sod or pea gravel.
9. Cut and route downspouts or other rainwater delivery components, leaf screen option(s) chosen (circle selected options in Pretreatment Options Detail figure). Strap and support as needed.
10. Create a safe overflow at least 10 feet from your property edge and insure it is protected from erosion.

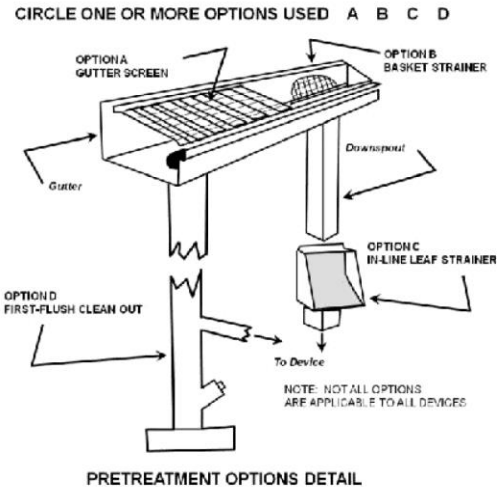

METRO NASHVILLE DEPARTMENT OF WATER SERVICES	NAME/ADDRESS:	MODIFIED FRENCH DRAIN SPECIFICATIONS PAGE 1 OF 2
--	---------------	--

**SKETCH LAYOUT**

PROVIDE PLAN AND ELEVATION VIEWS OF MFD AND HOUSE SHOWING ROOF AREA DIRECTED TO MFD AND KEY DIMENSIONS, CONNECTIONS AND OVERFLOW RELATIVE TO PROPERTY LINE.



**SIZING CALCULATION:**

Rooftop Area (square feet)	Depth of Gravel From Top of Pipe (inches)			
	18	24	30	36
	Required Linear Feet of MFD			
100	6	5	4	3
500	30	25	20	15
1000	60	45	40	35
2000	120	95	75	65
3000	185	140	115	100
4000	245	190	155	130
5000	305	235	195	165

MEASURE CONTRIBUTING DRAINAGE AREA AND READ AREA FOR GIVEN MEDIA DEPTH.

CONTRIBUTING DRAINAGE AREA= \_\_\_\_\_ SQ FT  
 DEPTH OF STONE MEDIA= \_\_\_\_\_ INCHES  
 WIDTH OF TRENCH= \_\_\_\_\_ INCHES  
 LENGTH OF MFD= \_\_\_\_\_ FT

**MAINTENANCE:**

1. INSPECT GUTTERS AND DOWNSPOUTS REMOVING ACCUMULATED LEAVES AND DEBRIS, CLEANING LEAF REMOVAL SYSTEM(S).
2. IF APPLICABLE, INSPECT PRETREATMENT DEVICES FOR SEDIMENT ACCUMULATION. REMOVE ACCUMULATED TRASH AND DEBRIS.
3. INSPECT MFD FOLLOWING A LARGE RAINFALL EVENT TO ENSURE OVERFLOW IS OPERATING AND FLOW IS NOT CAUSING PROBLEMS.

METRO NASHVILLE  
 DEPARTMENT OF  
 WATER SERVICES

ATTACHED THIS TWO-  
 PAGE SPECIFICATION TO  
 HOUSE PLAN SUBMITTAL

MODIFIED FRENCH DRAIN  
 SPECIFICATIONS  
 PAGE 2 OF 2



## E. PERMEABLE PAVERS

Permeable pavers are an alternative to traditional paving surfaces that can decrease stormwater runoff around your home. They are well suited for use when constructing sidewalks, parking areas, patios, and driveways. Permeable pavers consist of permeable interlocking or grid concrete pavers underlain by a drainage layer. A permeable paver system allows stormwater runoff to pass in between the paver surface and into an underlying stone reservoir, where it is temporarily stored and allowed to infiltrate into the underlying soils. Permeable pavers can provide significant reductions in stormwater runoff and pollutant loads in your watershed.

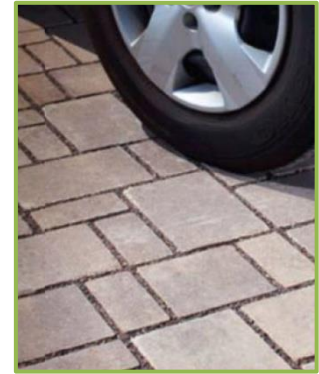

### LOCATION

- Maximum contributing drainage area ratio to surface area is 4:1.
- Permeable paver systems should be located at least 5 feet from building foundations and 10 feet from buildings with basements.  
 Permeable pavers should not be located: (1) above an area with a water table or bedrock less than two feet below the gravel bottom; (2) over other utility lines; or, (3) above a septic field. Always call 811 to locate utility lines before you dig.
- Permeable pavers should drain only impervious areas. Drainage from other areas onto the pavers will eventually clog them.
- The desirable soil infiltration rate suitable for a paver system is 0.50 inches per hour (in/hr) or greater. If there is concern due to tight soils when digging an infiltration test should be done as per the guidance provided in Section B. If the rate is less than 0.5 in/hr an underdrain leading to daylight should be provided. Professional assistance should be obtained in this case.
- Permeable paver systems should be installed on slopes less than 6% to help insure even distribution of runoff over the infiltration surface and should slope away from structures.

### CONSTRUCTION

The table at the right provides Permeable Paver area size requirements for different depths of the #57 stone layer. This stone averages in size from ½ inch to 1-1/2 inches. Example: A roof top is 1000 square feet. For a stone depth of 8 inches the required area of permeable pavers 280 sq ft.

Contributing Drainage Area (square feet)	Depth of Lower Stone Storage Layer (inches)				
	3	4	5	6	8
	Area of Pavers (square feet)				
100	54	45	39	34	27
500	280	230	200	170	140
1000	550	460	390	340	280
2000	1090	910	780	680	550
3000	1630	1360	1170	1020	820
4000	2180	1810	1560	1360	1090
5000	2720	2270	1940	1700	1380

- Permeable paver systems require multiple layers. Manufacturer’s instructions, if they exist, should be followed in lieu of these guidelines.
- The top course consists of the pavers and a crushed aggregate material swept between the paver joints, such as #8 stone or 1/8” to 3/8” pea gravel. The thickness of this layer varies depending upon the depth of the paver.
- The bedding course consists of 2 to 3 inches of #8 stone or 1/8” to 3/8” pea gravel. The bedding course provides a level bed for setting the pavers evenly.



- The aggregate base course consists of #57 stone, a minimum of 3 inches. The aggregate base course acts as a reservoir to provide stormwater storage capacity and must be compacted.
- As an option, a permeable drainage fabric can be used to separate the aggregate base course and the subgrade. The permeable drainage fabric must have a flow rate greater than 125 gpm/sq ft.
- The subgrade layer is the layer of native soils below the gravel and the permeable drainage fabric (if used). The subgrade soil layer should be prepared by scarifying or tilling to a depth of 3 to 4 inches.

## MAINTENANCE

Maintenance is very important for permeable pavers systems, particularly in terms of ensuring that they continue to provide measurable stormwater management benefits over time.

- Remove accumulated sediment and debris from joint space monthly.
- Observe the permeable paver system for excessive ponding during storm events and repair as needed.
- Vacuum, sweep, or blow permeable paver surface quarterly to keep the surface free of sediment.
- New #8 stone may need to be swept into the space between stones as needed. Inspect permeable paver surface for deterioration annually. Repair or replace any damaged areas as needed.

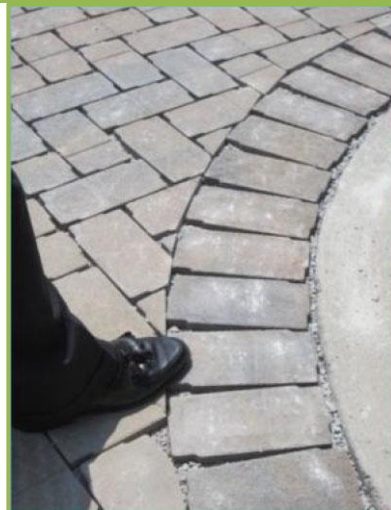

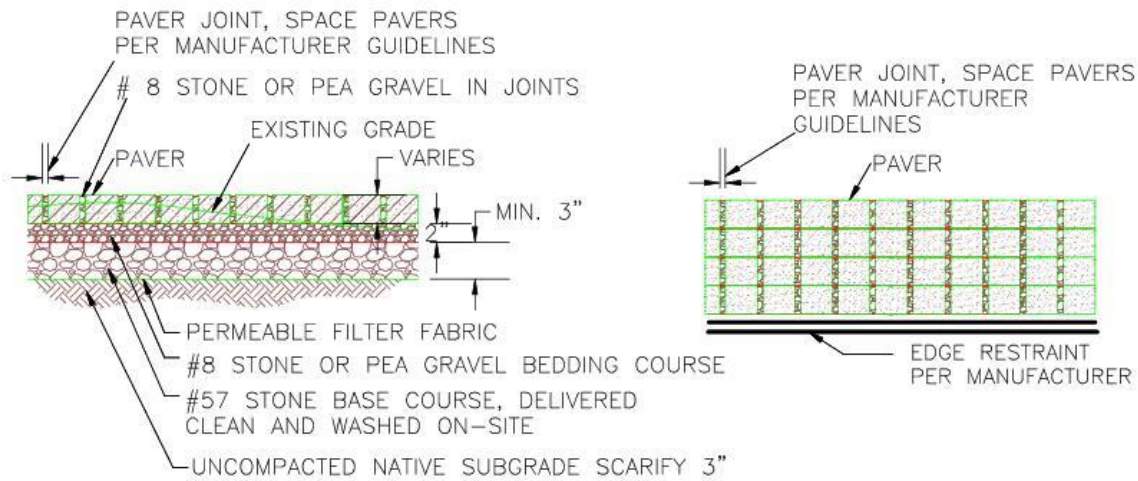

TYPICAL COMPONENTS (ATTACH MANUFACTURER’S SPECIFICATIONS)  
 CONSTRUCTION STEPS:

1. Review potential paver areas and layout. Pavers should slope less than 6% away from the structure and should not be located: (1) above an area with a water table or bedrock less than two feet below the trench bottom; (2) over other utility lines; or, (3) above a septic field.
2. Measure the area draining to the pavers and determine required paver area from the table on the next page based on the depth of the lower stone storage layer.
3. If soil is a concern perform infiltration test according to Section B. If the rate is less than 0.25 in/hr this method cannot be used. If the rate is more than 0.50 in/hr the pave area may be decreased 10% for every 0.50 in/hr infiltration rate increase above 0.50 in/hr.
4. Excavate area to appropriate depth and scarify soil to 3-4”.
5. Place, level and compact gravel to planned depth in no more than 6” lifts. Three-inch minimum depth.
6. Place, level and compact #8 stone or pea gravel bedding layer. Two-inch minimum depth.
7. Lay paving stone one at a time or using mechanical placement as applicable. Cut stone at edges to fit.
8. Install edge restraints per manufacturer’s specifications.
9. Sweep more #8 stone or pea gravel into stone joints until filled and even.
10. Cut and route downspouts or other rainwater delivery components, leaf screen option(s) chosen (circle selected options in Pretreatment Options Detail figure). Strap and support as needed.

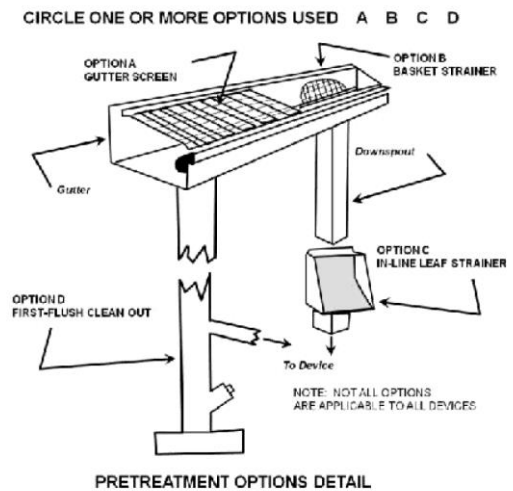

<p>METRO NASHVILLE          DEPARTMENT OF          WATER SERVICES</p>	<p>NAME/ADDRESS:</p>	<p>PERMEABLE PAVER          SPECIFICATIONS          PAGE 1 OF 2</p>
---	----------------------	---



SKETCH LAYOUT

PROVIDE PLAN AND ELEVATION VIEWS OF PERVIOUS PAVER AND HOUSE SHOWING ROOF AREA DIRECTED TO PAVERS AND KEY DIMENSIONS, CONNECTIONS AND ANY APPLICABLE OVERFLOW RELATIVE TO PROPERTY LINE. ATTACH MANUFACTURER'S SPECIFICATIONS IF APPLICABLE.

SIZING CALCULATION:

Contributing Drainage Area (square feet)	Depth of Lower Stone Storage Layer (inches)				
	3	4	5	6	8
	Area of Pavers (square feet)				
100	54	45	39	34	27
500	280	230	200	170	140
1000	550	460	390	340	280
2000	1090	910	780	680	550
3000	1630	1360	1170	1020	820
4000	2180	1810	1560	1360	1090
5000	2720	2270	1940	1700	1360

MEASURE CONTRIBUTING DRAINAGE AREA AND READ AREA FOR GIVEN MEDIA DEPTH.

CONTRIBUTING DRAINAGE AREA= \_\_\_\_\_ SQ FT  
 DEPTH OF STONE MEDIA= \_\_\_\_\_ INCHES  
 PAVER AREA= \_\_\_\_\_ SQ FT

MAINTENANCE:

1. REMOVE ACCUMULATED SEDIMENT AND DEBRIS FROM JOINT SPACE MONTHLY.
2. OBSERVE THE PERMEABLE PAVER SYSTEM FOR EXCESSIVE PONDING DURING STORM EVENTS AND REPAIR AS NEEDED.
3. VACUUM, SWEEP, OR BLOW PERMEABLE PAVER SURFACE QUARTERLY TO KEEP THE SURFACE FREE OF SEDIMENT. NEW STONE MAY NEED TO BE SWEEP INTO THE JOINTS AS NEEDED.
4. INSPECT PERMEABLE PAVER SURFACE FOR DETERIORATION ANNUALLY. REPAIR OR REPLACE ANY DAMAGED AREAS AS NEEDED.

METRO NASHVILLE  
 DEPARTMENT OF  
 WATER SERVICES

ATTACHED THIS TWO-PAGE  
 SPECIFICATION TO HOUSE  
 PLAN SUBMITTAL

PERMEABLE PAVER  
 SPECIFICATIONS  
 PAGE 2 OF 2



## F. RAIN GARDENS

Rain gardens are small, landscaped depressions that are filled with a mix of native soil and compost, and are planted with trees, shrubs and other garden-like vegetation. They are designed to temporarily store stormwater runoff from rooftops, driveways, patios and other areas around your home while reducing runoff rates and pollutant loads in your local watershed. A rain garden can be a beautiful and functional addition to your landscape.



### LOCATION

- Rain gardens should be located to receive the maximum amount of stormwater runoff from impervious surfaces, and where downspouts or driveway runoff can enter garden flowing away from the home.
- Swales, berms, or downspout extensions may be helpful to route runoff to the rain garden.
- Locate at least 10 feet from foundations, not within the public right of way, away from utility lines, not over septic fields, and not near a steep bluff edge. Call 811 before you dig to locate the utility lines on your property.
- Rain gardens on steep slopes (>10%) may require an alternative design with terracing.

### DESIGN

- The size of the rain garden will vary depending on the impervious surface draining to it and the depth of the amended soils. Use the table to determine the required surface area.
- A maximum ponding depth of 6 inches is allowed within rain gardens. On average, rain gardens drain within a day, which will not create a mosquito problem.
- Design rain garden entrance to immediately intercept inflow and reduce its velocity with stones, dense hardy vegetation or by other means.
- If sides are to be mowed rain gardens should be designed with side slopes of 3:1(H:V) or flatter.
- For best results, it is suggested to test your soil characteristics as you would for a garden, or contact your local County Extension Service for help (<https://ag.tennessee.edu/spp/Pages/soiltesting.aspx>).
- Soils for rain gardens should be amended native soils containing: 2/3 native soils and 1/3 compost.
- A mulch layer consisting of 2-3 inches of non-floatable organic mulch (fine shredded hardwood mulch, pine straw, or leaf compost) should be included on the surface of the rain garden. Pine bark and wood chips should not be used.
- Often rain gardens have a better appearance and can be more easily maintained if they have defined edges similar to a normal garden.
- The overflow from the rain garden should be non-eroding and can consist of a small berm or even an inlet grate set at the proper elevation in the garden. The grate should be set at a slant or be domed to allow clogging debris to fall off.

Contributing Drainage Area (square feet)	Depth of Amended Soil (inches)			
	18	24	30	36
	Area of Rain Garden (square feet)			
100	6.6	5.7	5.1	4.6
500	35	30	25	23
1000	65	60	50	45
2000	135	115	100	90
3000	200	170	150	140
4000	260	230	200	185
5000	330	290	255	230



## VEGETATION

- Vegetation commonly planted in rain gardens includes native trees, shrubs and other herbaceous vegetation. When developing a landscaping plan, you should choose vegetation that will be able to stabilize soils and tolerate the stormwater runoff rates and volumes that will pass through the rain garden.
- Vegetation used in rain gardens should also be able to tolerate both wet and dry conditions. Please refer elsewhere within this document for additional information on plants appropriate for rain gardens.
- As with any garden in the first season the vegetation may require irrigation to become well established. It may be appropriate to plant more densely than a normal garden to obtain the benefit of plant soil stabilization and evapotranspiration as soon as possible.

## MAINTAIN

Routine garden maintenance should include weeding, deadheading, replacing dead plants, and replenishing mulch when depleted. Catching areas of erosion is also important as is correcting standing water problems. If standing water persists it may be necessary to place a perforated underdrain in the garden daylighting downstream.



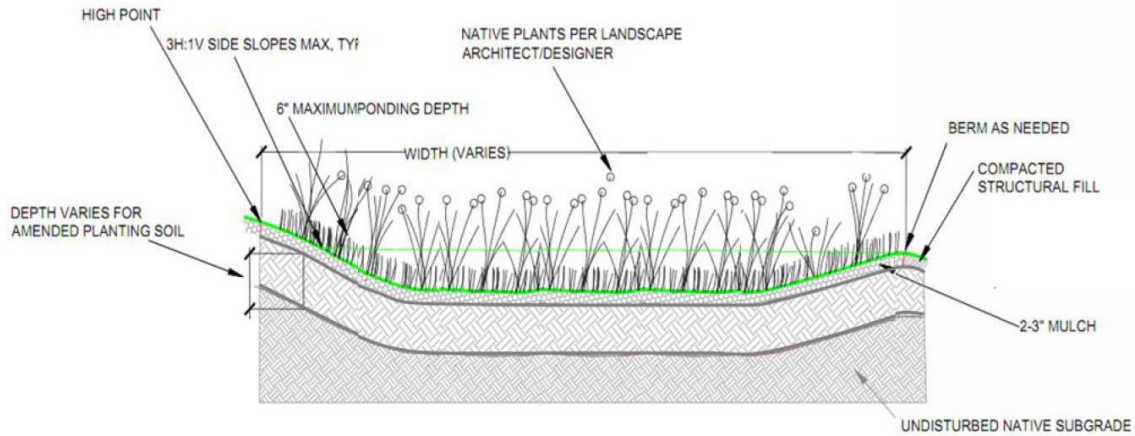

**CONSTRUCTION STEPS:**

1. Locate rain garden(s) where downspouts or driveway runoff can enter garden flowing away from the home. Locate at least 10 feet from foundations, not within the public right of way, away from utility lines, not over septic fields, and not near a steep bluff edge.
2. Measure the area draining to the planned garden and determine required rain garden surface area from the table on the next page and your planned excavation depth.
3. Optionally, perform infiltration test according to Section B. If the rate is less than 0.25 in/hr an underdrain will be necessary. If the rate is more than 0.50 in/hr the size of the garden may be decreased 10% for every 0.50 in/hr infiltration rate increase above 0.50 in/hr.
4. Measure elevations and stake out the garden to the required dimensions ensuring positive flow into garden, the overflow elevation allows for six inches of ponding, and the perimeter of the garden is higher than the overflow point. If the garden is on a gentle slope a berm at least two feet wide can be constructed on the downhill side and/or the garden can be dug into the hillside taking greater care for erosion control at the garden inlet(s).
5. Remove turf or other vegetation in the area of the rain garden. Excavate garden being careful not to compact soils in the bottom of the garden. Level bottom of garden as much as possible to maximize infiltration area.
6. Mix compost, topsoil, and some of the excavated subsoil together to make the 'amended soil'. The soil mix should be 1/3 compost, 2/3 native soil (topsoil and subsoil combined).
7. Fill rain garden with the amended soil, leaving the surface eight inches below your highest surrounding surface. Eight inches allows for 6 inches ponding and 2" of mulch. The surface of the rain garden should be as close to level as possible.
8. Build a berm at the downhill edge and sides of the rain garden with the remaining subsoil. The top of the berm needs to be level and set at the maximum ponding elevation.
9. Plant the rain garden using a selection of plants from elsewhere in this manual.
10. Mulch the surface of the rain garden with two to three inches of non-floating organic mulch. The best choice is finely shredded hardwood mulch. Pine straw is also an option.
11. Water all plants thoroughly. As in any new garden or flower bed, regular watering will likely be needed to establish plants during the first growing season.
12. During construction build the inlet feature as a pipe directly connected to a downspout or use a rock lined swale with a gentle slope. Use of an impermeable liner under the rocks at the end of the swale near the house is recommended to keep water from soaking in at that point. Test the drainage of water from the source to the garden prior to finishing.
13. Create an overflow at least 10 feet from your property edge and insure it is protected from erosion.

METRO NASHVILLE DEPARTMENT OF WATER SERVICES	NAME/ADDRESS:	RAIN GARDEN SPECIFICATIONS PAGE 1 OF 2
--	---------------	--



**SKETCH LAYOUT**

PROVIDE PLAN VIEWS OF RAIN GARDEN AND HOUSE SHOWING DRAINAGE AREA DIRECTED TO RAIN GARDEN AND KEY DIMENSIONS AND OVERFLOW AREA RELATIVE TO PROPERTY LINE.

**SIZING CALCULATION:**

Contributing Drainage Area (square feet)	Depth of Amended Soil (inches)			
	18	24	30	36
	Area of Rain Garden (square feet)			
100	6.6	5.7	5.1	4.6
500	35	30	25	23
1000	65	60	50	45
2000	135	115	100	90
3000	200	170	150	140
4000	260	230	200	185
5000	330	290	255	230

MEASURE CONTRIBUTING DRAINAGE AREA AND READ AREA FOR GIVEN MEDIA DEPTH.

CONTRIBUTING DRAINAGE AREA= \_\_\_\_\_ SQ FT  
 DEPTH OF SOIL MEDIA= \_\_\_\_\_ INCHES  
 AREA OF RAIN GARDEN= \_\_\_\_\_ SQ FT

- MAINTENANCE:**
1. IRRIGATE VEGETATION AS NEEDED IN FIRST SEASON
  2. REMOVE WEEDS
  3. REPLACE UNSUCCESSFUL PLANTINGS
  4. REPLENISH MULCH
  5. REPAIR ERODED AREAS
  6. RAKE CLOGGED SURFACE TO RESTORE INFILTRATION
  7. MONITOR RAIN GARDEN FOR APPROPRIATE DRAINAGE TIMES IF GARDEN DOES NOT DRAIN AN UNDERDRAIN MAY BE NECESSARY

METRO NASHVILLE  
 DEPARTMENT OF  
 WATER SERVICES

ATTACHED THIS TWO-PAGE  
 SPECIFICATION TO HOUSE  
 PLAN SUBMITTAL

RAIN GARDEN  
 SPECIFICATIONS  
 PAGE 2 OF 2



### III. RESIDENTIAL INFILL STORMWATER CREDIT FOR EXISTING TREES

Each tree with a Diameter at Breast Height (DBH) of 6 inches or greater that is protected can reduce the impervious area requiring treatment by 50 square feet. The following conditions shall be met:

- No more than 20% of the net added impervious area can be mitigated with the credit.
- The location, species, and size of each tree being counted for credit is shown on the plan of record. A picture of the tree should also be included with the application.
- The tree is protected during construction in accordance with M.C.L. §17.24.110 or the *Saving Trees During Construction* guidance document.
- Bradford Pears and Ash trees will not be counted for credit.
- With the exception of the Vegetated Filter Strip Green Infrastructure Control, trees that are located within the boundaries of constructed stormwater infrastructure features cannot be counted for Infill Stormwater Credit.

If the protected tree(s) dies or is removed, the property owner may be subject to enforcement and will be responsible for providing impervious area treatment. This may include planting and maintaining additional trees or installing Green Infrastructure Controls.



## IV. TESTING INFILTRATION: THE SIMPLE APPROACH

It is assumed that an infiltration rate of 0.25 to 0.50 inches per hour exists on residential sites. The sizing criteria are set for this rate. However, if the soils have a higher infiltration rate the size of the features could be reduced. At the discretion of the property owner the following infiltration test can be conducted, and if it returns a higher infiltration rate than 0.50 inches per hour suitable reductions in the size of the infiltration-based facilities can be made. See each practice for the adjustment procedure.

1. Infiltration features (rain gardens, dry wells, permeable paver gravel layers) should reliably drain within the recommended time limit. Here is how to test if your soils can handle this type of feature.
2. Locate the approximate center of the area where you expect to build your feature.
3. Dig an access pit down to the bottom of the amended soils or gravel layer in the feature.
4. At that elevation dig a narrow test hole at least eight inches deep. You can optionally place 2" of course gravel in the bottom. The test hole can be excavated with small excavation equipment or by hand using a spade shovel or post-hole digger.
5. If you run into a hard layer that cannot be penetrated with a shovel or, you come across water in the whole, stop. Infiltration features should not be sited over impenetrable rock surfaces or over high water tables, so your site is inappropriate.
6. Place a flat board across the hole to serve as a measuring point (see figure).
7. Fill the hole with water to a depth of six inches. Measure from the flat board to the water surface. Record the exact time you stop filling the hole and the height of the water every 10 minutes for fast draining soils for a minimum of one hour or every 30 minutes for slow draining soils for a minimum of two hours.
8. Refill the hole again and repeat step 5 twice more. The third test will give you the best measure of how quickly your soil absorbs water when it is fully saturated.
9. If on the third test the water is dropping at least  $\frac{1}{2}$ " per hour the soil will work for the infiltration features.

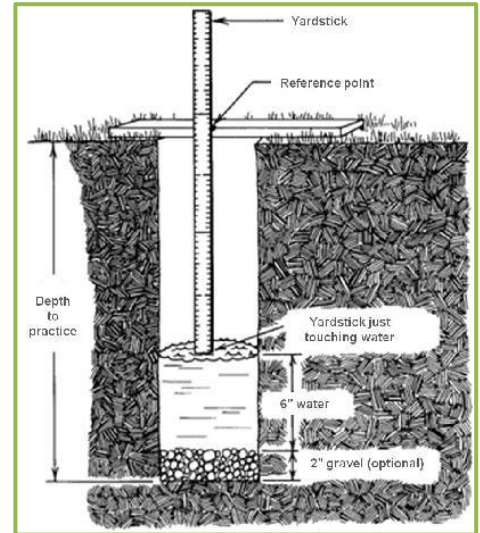

Source: modified from [www.ag.ndsu](http://www.ag.ndsu)



Source: [www.learntogrow.com](http://www.learntogrow.com)



## V. RECOMMENDED PLANTS

Plants for rain gardens and other vegetated stormwater practices must be able to tolerate both wet and dry conditions. This list, while not exhaustive, includes many plants that will tolerate conditions in rain gardens. The plants in this list do have different preferences for both moisture and light, as shown in the columns labeled 'Moisture' and 'Sun'. Additionally, the majority of these plants are native to central Tennessee and thus contribute the added benefit of providing habitat and food for native pollinators and wildlife. Native plant species are preferred over non-native species, but some ornamental species may be used for landscaping effect if they are not aggressive or invasive.

**Table 1.** is for use only when plants are spaced equidistant from each other as shown in **Figure 1.**, below.

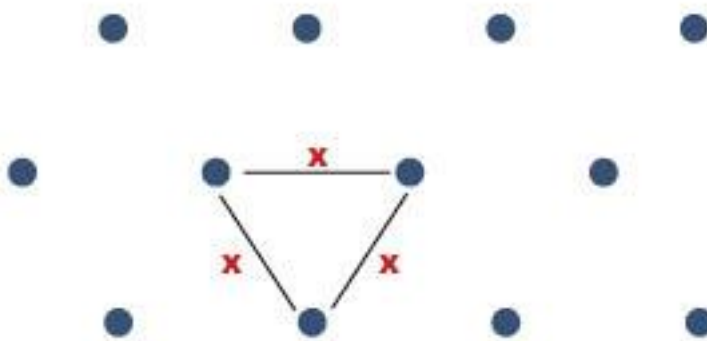

**Figure 1.** Typical plant spacing where *x* equals distance on center (O.C.) of plant species.

Table 1. Plant Spacing for Perennials, Grasses, Sedges and Shrubs	
Spacing (O.C.)	Plants per 100 sq.ft.
18" o.c.	51.2
24" o.c.	29
28" o.c.	22
30" o.c.	18.5
36" o.c.	12.8
42" o.c.	10
4' o.c.	7.23
5' o.c.	4.61
6' o.c.	3.2
8' o.c.	1.8



Table 2: Popular Native Perennials – Full Sun						
Latin Name	Common Name	Size	Spacing	Moisture	Color	Height
<i>Asclepias incarnate</i>	Marsh milkweed	Plugs – 1 gal	1 plant/24" o.c.	Wet	Pink	3-4'
<i>Asclepias purpurescens</i>	Purple milkweed	Plugs – 1 gal	1 plant/18" o.c.	Moist	Purple	3'
<i>Asclepias syriaca</i>	Common milkweed	Plugs – 1 gal	1 plant/18" o.c.	Moist-dry	Orange	2-5'
<i>Asclepias tuberosa</i>	Butterfly milkweed	Plugs – 1 gal	1 plant/18" o.c.	Dry-moist	Orange	2'
<i>Asclepias verdis</i>	Green milkweed	Plugs – 1 gal	1 plant/18" o.c.	Moist	Green	2'
<i>Asclepias verticillata</i>	Whorled milkweed	Plugs – 1 gal	1 plant/18" o.c.	Moist	White	2.5'
<i>Aster laevis</i>	Smooth aster	Plugs – 1 gal	1 plant/18" o.c.	Moist	Blue	2-4'
<i>Aster novae-angliae</i>	New England aster	Plugs – 1 gal	1 plant/24" o.c.	Wet-moist	Blue	2-5'
<i>Aster sericeus</i>	Silky aster	Plugs – 1 gal	1 plant/18" o.c.	Dry	Purple	1-2'
<i>Chamaecrista fasciculata</i>	Partridge pea	Plugs – 1 gal	1 plant/18" o.c.	Dry	Yellow	1-2'
<i>Conoclinium coelestinum</i>	Mist flower	Plugs – 1 gal	1 plant/18" o.c.	Moist-dry	Blue	1-2'
<i>Coreopsis lanceolata</i>	Lance-leaf coreopsis	Plugs – 1 gal	1 plant/18" o.c.	Moist-dry	Yellow	6-8'
<i>Echinacea pallida</i>	Pale purple coneflower	Plugs – 1 gal	1 plant/18" o.c.	Dry	Purple	2-3'
<i>Echinacea purpurea</i>	Purple coneflower	Plugs – 1 gal	1 plant/18" o.c.	Moist-dry	Purple	3-4'
<i>Eupatorium perfoliatum</i>	Boneset	Plugs – 1 gal	1 plant/24" o.c.	Wet	White	3-5'
<i>Eupatorium purpureum</i>	Sweet Joe-Pye Weed	Plugs – 1 gal	1 plant/24" o.c.	Wet-moist	Purple	3-6'
<i>Iris virginica</i>	Flag Iris	Plugs – 1 gal	1 plant/18" o.c.	Moist-Wet	Blue	2'
<i>Liatris aspera</i>	Rough blazingstar	Plugs – 1 gal	1 plant/18" o.c.	Moist-dry	Purple	2-5'
<i>Liatris microcephalla</i>	Small-headed blazingstar	Plugs – 1 gal	1 plant/18" o.c.	Moist-dry	Purple	3'
<i>Liatris spicata</i>	Dense blazingstar	Plugs – 1 gal	1 plant/24" o.c.	Wet-moist	Purple	1.5'
<i>Liatris squarrulosa</i>	Southern blazingstar	Plugs – 1 gal	1 plant/18" o.c.	Moist-dry	Purple	2-6'
<i>Lobelia cardinalis</i>	Cardinal flower	Plugs – 1 gal	1 plant/18" o.c.	Wet-moist	Red	2-4'
<i>Monarda didyma</i>	Bee balm	Plugs – 1 gal	1 plant/24" o.c.	Wet-moist	Red	3'
<i>Monarda fistulosa</i>	Wild bergamot	Plugs – 1 gal	1 plant/18" o.c.	Moist	Purple	1-3'
<i>Oenothera fruticosa</i>	Sundrops	Plugs – 1 gal	1 plant/18" o.c.	Moist-dry	Yellow	
<i>Penstemon digitalis</i>	Smooth white beardtongue	Plugs – 1 gal	1 plant/24" o.c.	Wet	White	2-3'
<i>Penstemon hirsutus</i>	Hairy beardtongue	Plugs – 1 gal	1 plant/18" o.c.	Dry	White	1-3'
<i>Penstemon smallii</i>	Beardtongue	Plugs – 1 gal	1 plant/18" o.c.	Moist	Purple	1-2'
<i>Pycnanthemum tenuifolium</i>	Slender mountain mint	Plugs – 1 gal	1 plant/18" o.c.	Moist	White	1.5-2.5'
<i>Ratibida pinnata</i>	Gray-headed coneflower	Plugs – 1 gal	1 plant/18" o.c.	Moist	Yellow	2-5'
<i>Rudbeckia hirta</i>	Black-eyed Susan	Plugs – 1 gal	1 plant/18" o.c.	Moist-dry	Yellow	3'
<i>Salvia lyrata</i>	Lyre-leaf sage	Plugs – 1 gal	1 plant/18" o.c.	Moist	Purple	1-2'
<i>Solidago nemoralis</i>	Gray goldenrod	Plugs – 1 gal	1 plant/18" o.c.	Dry	Yellow	2'
<i>Solidago rugosa</i>	Rough-leaved goldenrod	Plugs – 1 gal	1 plant/18" o.c.	Wet	Yellow	1-6'
<i>Veronicastrum virginicum</i>	Culver's root	Plugs – 1 gal	1 plant/24" o.c.	Dry	White	3-6'
<i>Veronia veboracensis</i>	Tall ironweed	Plugs – 1 gal	1 plant/24" o.c.	Wet-moist	Purple	3-4'

Plant material size and grade to conform to "American Standards for Nursery Stock" American Association of Nurserymen, Inc. latest approved revision, ANSI Z-60-1



**Table 3: Popular Native Perennials – Shade**

Latin Name	Common Name	Size	Spacing	Moisture	Color	Height
<i>Aquilegia canadensis</i>	Wild columbine	Plugs – 1 gal.	1 plant/18” o.c.	Moist-dry	Pink	1-2.5’
<i>Athyrium filix-femina</i>	Lady Fern	1 gal.	1 plant/18” o.c.	Moist	Green	3’
<i>Arisaema triphyllum</i>	Jack-in-the-pulpit	Plugs – 1 gal.	1 plant/18” o.c.	Moist	Green	1.5-2.5’
<i>Arisaema dricontium</i>	Green dragon	Plugs – 1 gal.	1 plant/18” o.c.	Wet-moist	Green	3’
<i>Asarum canadense</i>	Wild ginger	Plugs – 1 gal.	1 plant/18” o.c.	Wet-moist	Red-brown	0.5-1’
<i>Aster cardifolius</i>	Blue wood aster	Plugs – 1 gal.	1 plant/18” o.c.	Moist-dry	Blue	1-3’
<i>Aster novae-angliae</i>	New England aster	Plugs – 1 gal.	1 plant/24” o.c.	Moist-dry	Blue/ purple	3-4’
<i>Aster oblongifolius</i>	Aromatic Aster	Plugs – 1 gal.	1 plant/24” o.c.	Moist-dry	Blue/ purple	1.5-3’
<i>Coreopsis major</i>	Tickseed coreopsis	Plugs – 1 gal.	1 plant/18” o.c.	Moist-dry	Yellow	3’
<i>Dryopteris marginalis</i>	Shield Fern	1 gal.	1 plant/18” o.c.	Moist	Green	2-3’
<i>Geranium maculatum</i>	Wild geranium	Plugs – 1 gal.	1 plant/18” o.c.	Moist	Pink	2’
<i>Heuchera americana</i>	Alumroot	Plugs – 1 gal.	1 plant/18” o.c.	Moist-dry	Purple	1’
<i>Iris cristata</i>	Dwarf crested iris	Plugs – 1 gal.	1 plant/18” o.c.	Moist-dry	Purple	4”
<i>Lobelia siphilicata</i>	Great blue lobelia	Plugs – 1 gal.	1 plant/18” o.c.	Wet-moist	Blue	1.5-3’
<i>Lobelia cardinalis</i>	Cardinal flower	Plugs – 1 gal.	1 plant/18” o.c.	Wet-moist	Red	2-4’
<i>Mertensia virginica</i>	Virginia bluebells	Plugs – 1 gal.	1 plant/18” o.c.	Moist	Blue	1.5’
<i>Osmunda cinnamomea</i>	Cinnamon Fern	1 gal.	1 plant/24” o.c.	Wet-moist	Green	3-4’
<i>Phlox divaricata</i>	Blue phlox	Plugs – 1 gal.	1 plant/18” o.c.	moist	Blue	0.5-2’
<i>Polemonium reptans</i>	Jacob’s ladder	Plugs – 1 gal.	1 plant/18” o.c.	Moist-dry	Blue	15”
<i>Polystichum acrostichoides</i>	Christmas fern	Plugs – 1 gal.	1 plant/24” o.c.	Moist-dry	Evergreen	2’
<i>Stylophoru diphyllum</i>	Wood poppy	Plugs – 1 gal.	1 plant/18” o.c.	Wet - moist	Yellow	1.5’

Plant material size and grade to conform to “American Standards for Nursery Stock” American Association of Nurserymen, Inc. latest approved revision, ANSI Z-60-1.



**Table 4: Popular Native Grasses and Sedges**

Latin Name	Common Name	Size	Spacing	Moisture	Color	Height
<i>Carex grayi</i>	Gray's Sedge	1 gal.	1 plant/24" o.c.	Moist	Green	3'
<i>Carex muskingumensis</i>	Palm Sedge	1 gal.	1 plant/24" o.c.	Moist	Green	3'
<i>Carex stricta</i>	Tussock Sedge	1 gal.	1 plant/24" o.c.	Moist	Green	3-4'
<i>Chasmanthium latifolium</i>	Upland Sea Oats	Plugs – 1 gal.	1 plant/18" o.c.	Moist-dry	Green	4'
<i>Equisetum hyemale</i>	Horsetail	Plugs – 1 gal.	1 plant/18" o.c.	Wet	Green	3'
<i>Juncus effesus</i>	Soft Rush	Plugs – 1 gal.	1 plant/24" o.c.	Wet-dry	Green	4-6'
<i>Muhlenbergia capallaris</i>	Muhly Grass	1 gal.	1 plant/24" o.c.	Moist	Pink	3'
<i>Panicum virgatum</i>	Switchgrass	1-3 gal.	1 plant/48" o.c.	Moist-dry	Yellow	5-7'
<i>Schizachyrium scoparium</i>	Little Blue Stem	1 gal.	1 plant/24" o.c.	Moist-dry	Yellow	3'
<i>Sporobolus heterolepis</i>	Prairie Dropseed	1 gal.	1 plant/24" o.c.	Moist-dry	Green	2-3'

Plant material size and grade to conform to “American Standards for Nursery Stock” American Association of Nurserymen, Inc. latest approved revision, ANSI Z-60-1.



Table 5: Popular Native Small Trees							
Latin Name	Common Name	DT-FT	Light	Moisture	Notes	Flower Color	Height
<i>Ameleanchier Canadensis</i>	Serviceberry		Sun-pt shade	Moist-wet	Eatable berries	White	15-25'
<i>Asimina triloba</i>	Paw Paw		Sun-pt shade	Moist	Eatable fruits	Maroon	15-30'
<i>Cercus Canadensis</i>	Redbud	DT	Sun-shade	Moist	Pea-like flowers, seed pods	Purple	20-30'
<i>Chionanthus virginicus</i>	Fringetree		Sun-pt shade	Moist	Paniced, fragrant flowers	White	12-20'
<i>Cornus florida</i>	Flowering Dogwood		Part Shade	Moist	Red fruit, wildlife	White	15-30'
<i>Magnolia virginiana</i>	Sweetbay Magnolia		Sun-pt shade	Moist-wet	Evergreen	White	10-60'
<i>Rhamnus caroliniana</i>	Carolina Buckthorn		Sun	Moist	Black fruit		15-30'

Size: min. 2" caliper

DT: Drought Tolerant FT: Flood Tolerant

Plant material size and grade to conform to "American Standards for Nursery Stock" American Association of Nurserymen, Inc. latest approved revision, ANSI Z-60-1.



Table 6: Popular Native Medium-Large Trees							
Latin Name	Common Name	DT-FT	Light	Moisture	Notes	Flower Color	Height
<i>Acer rubrum</i>	Red Maple	DT-FT	Sun-shade	Dry-wet	Fall Color		50-70'
<i>Acer saccharum</i>	Sugar Maple		Sun-pt shade	Moist	Fall Color		50-75'
<i>Betula nigra</i>	River Birch	FT	Sun-pt shade	Moist-wet	Exfoliating bark		40-70'
<i>Carpinus caroliniana</i>	Ironwood		Sun-pt shade	Moist		White	40-60'
<i>Carya aquatica</i>	Water Hickory	FT-DT	Sun	Moist	Fall Color		35-50'
<i>Cladratis lutea</i>	Yellowwood	DT	Sun	Dry-moist	Fall Color	White	30-45'
<i>Ilex opaca</i>	American Holly	DT	Sun-pt shade	Moist	Evergreen	White	30-50'
<i>Liquidambar styraciflua</i>	Sweetgum	DT-FT	Sun-pt shade	Dry-moist	Spiny fruit		60-100'
<i>Nyssa sylvatica</i>	Black Gum		Sun-shade	Moist	Fall Color		35-50'
<i>Oxydendrum arboretum</i>	Sourwood		Sun-pt shade	Dry-moist	Wildlife	White	20-40'
<i>Platanus occidentalis</i>	Sycamore	FT	Sun-pt shade	Moist	White mottled bark		70-100'
<i>Quercus bicolor</i>	Swamp White Oak	DT	Sun-pt shade	Moist-wet	Acorns		50-60'
<i>Quercus nuttalli</i>	Nuttal Oak	DT	Sun	Dry-moist	Acorns		40-60'
<i>Quercus lyrata</i>	Overcup Oak	FT	Sun	Moist	Acorns		40-60'
<i>Quercus shumardii</i>	Shumard Oak	DT	Sun	Moist	Acorns		40-60'
<i>Salix nigra</i>	Black Willow	FT	Sun-pt shade	Moist-wet	White catkins	Yellow	40-60'
<i>Ulmus americana</i>	American Elm	DT-FT	Sun-pt shade	Moist			

Size: min. 2" caliper

DT: Drought Tolerant FT: Flood Tolerant

Plant material size and grade to conform to "American Standards for Nursery Stock" American Association of Nurserymen, Inc. latest approved revision, ANSI Z-60-1.



**Table 7: Popular Native Small-Medium Shrubs**

Latin Name	Common Name	DT-FT	Light	Moisture	Spacing	Notes	Flower Color	Height
<i>Buddleia davidii</i>	Butterfly Bush	DT	Sun-pt shade	Dry-moist	4'	Non-native	Blue	5'
<i>Callicarpa Americana</i>	American Beautyberry	DT	Sun-pt shade	Dry-wet	5'	Showy purple fruit	Lilac	4-6'
<i>Clethra alnifolia</i>	Sweet Pepper Bush		Sun-pt shade	Dry-moist	3'	Hummingbird	White	5-8'
<i>Hibiscus moscheutos</i>	Swamp Mallow	FT	Sun	Moist-wet	30"	Cold-hardy	White-red	4-7'
<i>Hydrangea quercifolia</i>	Oakleaf Hydrangea	DT	Pt shade-shade	Moist	4'	Winter texture	White	3-6'
<i>Hypericum frondosum</i>	Golden St. John's Wort	DT	Sun-pt shade	Dry-moist	30"	Semi-evergreen	Yellow	2-3'
<i>Hypericum prolificum</i>	Shrubby St. John's Wort	DT	Sun-pt shade	Dry-moist	3'	Semi-evergreen	Yellow	3'
<i>Ilex glabra</i>	Inkberry	DT	Sun-pt shade	Moist-wet	3'	Evergreen		4-8'
<i>Itea virginica</i>	Virginia Sweetspire	DT-FT	Sun-Shade	Moist-wet	4'	Fall color	White	4-8'
<i>Viburnum dentatum</i>	Arrowwood Viburnum		Sun-shade	Dry-wet	6'	Wildlife	White	6-8'

Size: min. 3 gal. container or equivalent.

DT: Drought Tolerant FT: Flood Tolerant

This list provides plant species; there are multiple varieties within each species.

Plant material size and grade to conform to “American Standards for Nursery Stock” American Association of Nurserymen, Inc. latest approved revision, ANSI Z-60-1.



Table 8: Popular Native Large Shrubs							Flower Color	Height
Latin Name	Common Name	DT-FT	Light	Moisture	Spacing	Notes		
<i>Aronia arbutifolia</i>	Red Chokeberry	FT	Sun-pt shade	Dry-wet	4'	Red berries, wildlife	White	6-12'
<i>Cephalanthus occidentalis</i>	Button Bush	FT	Sun-shade	Moist-wet	5'	Attracts wildlife	White	6-12'
<i>Cornus amomum</i>	Silky Dogwood		Sun-shade	Moist-wet	6'	Blue berries, wildlife	White	6-12'
<i>Corylus americana</i>	American Hazelnut		Sun-pt shade	Dry-moist	8'	Eatable nuts, wildlife	Yellow	8-15'
<i>Hamamelis virginiana</i>	Witch-hazel		Sun-pt shade	Dry-moist	8'	Winter bloom	Yellow	10'
<i>Ilex decidua (dwarf var.)</i>	Possumhaw Viburnum	DT	Sun-pt shade	Moist	4-6'	Red berries		6-14'
<i>Illex verticillata</i>	Winterberry Holly	FT	Sun-pt shade	Moist-wet	3'	Red berries		10'
<i>Lindera benzoin</i>	Spicebush	DT	pt shade-shade	Moist-wet	8'	Butterflies, wildlife	Yellow	6-12'

Size: minimum 3 gal. container or equivalent.

DT: Drought Tolerant FT: Flood Tolerant

This list provides plant species; there are multiple varieties within each species.

Plant material size and grade to conform to “American Standards for Nursery Stock” American Association of Nurserymen, Inc. latest approved revision, ANSI Z-60-1.



## VI. THE SIMPLE METHOD OF DETERMINING ADEQUATE FLOW AREA

This method is only to be used to determine adequate flow area required for projects that are classified as a Tier 1 development.

**Step 1:** Determine flow patterns on your project site, specifically where flow exits the project.

**Step 2:** Where flow exits the site determine existing flow area of the exiting drainage channels on your site using the schematic and equation below in Figure 1. Mark on the plans where flow area was determined.

**Step 3:** Once flow area has been calculated, determine the impervious area (IA) of the project and the nearest lot area to determine the required flow area for your site.

**Step 4:** A) If the result of **Step 2** is *less* than **Step 3** adequate drainage is not present and the developer must follow Tier 2 guidelines. B) If the result of **Step 2** is *greater* than **Step 3** adequate drainage is present. If B, then the developer must submit calculations and site plan to the Development Services Center for verification.

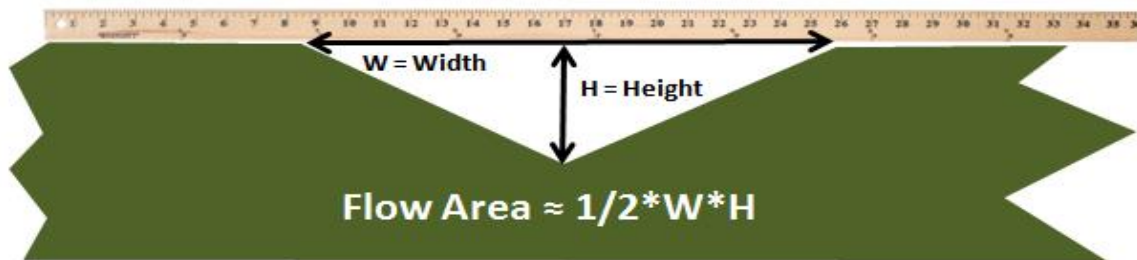

Figure 1 Simple Method Flow Area Calculation



**Table 1 Simple Method Flow Area Required**

Flow Area in Square Feet							
IA (sq ft).	Total lot area -->		1/4 Acre		1/2 Acre		1 Acre
	1,000	5,000	10,890	15,000	21,780	30,000	40,000
1,200	0.12	0.19	0.29	0.36	0.48	0.62	0.80
2,500	0.23	0.30	0.40	0.47	0.59	0.73	0.91
3,000	0.27	0.34	0.44	0.51	0.63	0.78	0.95
4,000	0.35	0.42	0.53	0.60	0.72	0.86	1.03
5,000	0.44	0.51	0.61	0.68	0.80	0.94	1.12
7,500	0.65	0.72	0.82	0.89	1.01	1.15	1.33
10,000	0.86	0.93	1.03	1.10	1.22	1.36	1.54
30,000	2.53	2.60	2.71	2.78	2.90	3.04	3.21
40,000	3.37	3.44	3.54	3.62	3.74	3.88	4.05

Read impervious area on the left then read across to right the nearest TOTAL lot size  
 Concrete channel flow area is 2/3 of the vegetated channel



## **VII. DECLARATION OF RESTRICTIONS AND COVENANTS FOR SCMS FOR REGULATED RESIDENTIAL INFILL**



*This page intentionally left blank*



This instrument prepared by:  
Metropolitan Department of Law  
108 Metropolitan Courthouse  
Nashville, Tennessee 37201

**DECLARATION OF RESTRICTIONS AND COVENANTS  
FOR  
SCMs FOR REGULATED RESIDENTIAL INFILL**

SWSF Permit No.: \_\_\_\_\_

Being on the Property conveyed to \_\_\_\_\_, the ownership deed for which is of record in Instrument No. \_\_\_\_\_, R.O.D.C., Tennessee.

\_\_\_\_\_ (individually or collectively, the “Declarant”), the owner of the real property described in Exhibit(s) A attached hereto and incorporated herein by reference (the “Property”), does hereby covenant, agree and declare as follows:

1. Declarant is lawfully seized of the Property and possessed of said land in fee simple and has good right to make the following declarations and covenants.
2. Declarant has prepared and submitted to Metro a Long Term Maintenance Plan (the “Plan”) acceptable to Metro, a copy of which is attached hereto, and shall thereafter provide for adequate long term maintenance and continuation of the stormwater control measures/green infrastructure control practices described in the Plan to ensure that all stormwater systems (“Systems”) required by the Plan are and remain in proper working condition in accordance with the Plan and with all applicable rules, regulations and laws. Declarant shall perform preventative maintenance activities at intervals described in the inspection schedule included in the Plan along with necessary landscaping (grass cutting, etc.) and trash removal as part of regular maintenance.
3. Declarant shall submit to Metro an annual report by July 1<sup>st</sup> of each year or as requested by Metro. The report shall document the inspection schedule, times of inspection, remedial actions taken to repair, modify or reconstruct Systems, the state of stormwater control measures/green infrastructure control practices, and notification of any planned change in responsibility for such Systems.
4. Declarant hereby accords to Metro and its employees, agents and contractors a perpetual right of entry at reasonable times and in a reasonable manner for the purpose of inspecting or operating the Systems.
5. Declarant hereby accords to Metro and its employees, agents and contractors a perpetual right of entry for access from public rights-of-way to the Systems.



6. If, upon inspection, Metro determines that Declarant has failed to properly maintain the Systems in accordance with the Plan, the Declarant acknowledges that Metro will in that event have the authority to order Declarant to perform such maintenance within ten (10) days. Declarant acknowledges and understands that Metro is under no duty or obligation to maintain or repair the Systems.
7. Declarant shall reimburse Metro in full upon demand in the amount of any judgment rendered against Metro due to Declarant's failure to perform the obligations created by this instrument.
8. The Property may be used for any lawful purpose desired after the construction of all of the Systems, provided that structural change, in the opinion of Metro (the discretion to give such opinion on behalf of Metro may be exercised by the Director of Water and Sewerage Services, or the Director's designee), will not destroy, weaken or damage them or interfere with their operation or maintenance. Additionally, prior to any changes or additions to or relocation of the improvements, the Declarant, successors and/or assigns must demonstrate to the satisfaction of the Director of Water and Sewerage Services that any such proposed change, addition, or relocation will not eliminate the improvement or interfere with or significantly change its needed operation, or otherwise pose a danger to the public health or safety. A map depicting any approved change, addition, or relocation of the improvements shall be recorded with reference to this instrument number.
9. These restrictions and covenants under this instrument shall become void if the structures on the property are demolished, the property is prepared for redevelopment.

The Declarant shall provide this executed document along with associated recording fees (payable to the Davidson County Register of Deeds) to Metro Water Services for the purpose of recording this Declaration. Upon the recording of this Declaration by Metro in the office of the Register of Deeds for the county of Davidson, Tennessee, the foregoing restrictions and covenants shall run with the land and shall be binding on Declarant and all subsequent owners of the Property (or any portion thereof) and shall inure to the benefit of and be enforceable by Metro, its successors and assigns (although Metro's failure to exercise its enforcement rights in any particular situation shall not be deemed a waiver of them). Declarant, for itself and its successors in interest, further covenants to warrant and forever defend Metro's enforcement rights regarding the foregoing restrictions and covenants against the adverse claims of all persons. The foregoing covenants and restrictions may not be modified or amended except by a recorded instrument signed by Declarant and Metro (the discretion to do so on behalf of Metro may be exercised by the Director), or their respective successors or assigns, and shall not be extinguished by merger of title or otherwise.



WITNESS my/our hand(s), this \_\_ day of \_\_\_\_\_, 20\_\_.

\_\_\_\_\_  
Declarant

\_\_\_\_\_  
Declarant

**STATE OF TENNESSEE  
COUNTY OF DAVIDSON**

Before me, \_\_\_\_\_, a Notary Public of the State and County

aforsaid, personally appeared \_\_\_\_\_

with whom I am personally acquainted, and who, upon oath,  
acknowledged \_\_\_\_\_

to be \_\_\_\_\_

the within named bargainer(s), \_\_\_\_\_ and that \_\_\_\_\_, as

such \_\_\_\_\_

being authorized to do so, executed the foregoing instrument for the purposes therein contained.

Witness my hand and seal this \_\_\_\_ day of \_\_\_\_\_, 20\_\_.

\_\_\_\_\_, Notary Public

My Commission Expires \_\_\_\_\_.



---

---

**FOR GOVERNMENT USE ONLY**

I, \_\_\_\_\_, do hereby make oath that I am a licensed attorney and/or the custodian of the original version of the electronic document tendered for registration herewith and that this is a true and correct copy of the original documents executed and authenticated according to law as of \_\_\_\_\_.  
Date

This instrument has been reviewed and approved by the Metro Water, Property Services.

\_\_\_\_\_  
Signature

**STATE OF TENNESSEE  
COUNTY OF DAVIDSON**

Personally appeared before me, the undersigned, a notary for this County and State, \_\_\_\_\_, who acknowledges that this certification of an electronic document is true and correct and whose signature I have witnessed.

\_\_\_\_\_  
Notary Signature

MY COMMISSION EXPIRES: \_\_\_\_\_  
Notary's Seal



*This page intentionally left blank*



## VIII. LONG TERM MAINTENANCE PLAN INSTRUCTIONS

The Long Term Maintenance Plan is a component of the Maintenance Document for the development or site. One of the purposes of the Long Term Maintenance Plan is to inform property owners about the system components on their properties, so that they will know the locations and maintenance needs of the components and structural SCMs.

The Long Term Maintenance Plan must include or address the following elements:

- Description of the stormwater system components and a site map showing the location of each. For sites designed in accordance with the SWMM, Volume 5, the LID Manual, this includes a site map showing areas of open space that received credit for lowering the site weighted runoff coefficient. Ongoing site SCM inspection and maintenance compliance shall include verification that such areas remain as open space as indicated on the plans.
- Schedule of inspections and the techniques used to inspect and maintain the systems to ensure that they are functioning properly as designed.
- Where and how the trash, sediment and other pollutants removed from the stormwater system will be disposed.
- Schematics of SCMs located on the site. Landscape plans should also be included for bioretention areas.
- Person(s) and phone number(s) of who will be responsible for inspection and maintenance. If the organization that will be responsible is yet to be organized, list the name, address, and phone number of the person or entity with interim responsibility.
- Provisions for permanent access and maintenance easements.



*This page intentionally left blank*